

Six Sigma

Graeme Knowles



Download free books at

bookboon.com

Graeme Knowles

Six Sigma

Six Sigma

© 2011 Graeme Knowles & bookboon.com

ISBN 978-87-7681-852-4

Contents

1	Introduction	10
2	Background and History	11
2.1	Development of Quality Thinking	11
2.2	Six Sigma: The Next Evolution	12
2.3	Definition of Six Sigma	13
2.4	Summary	13
3	Why Six Sigma?	14
3.1	Introduction	14
3.2	To Improve Financial Performance and Profitability	14
3.3	To be Responsive to, and Focused on, Customers	17
3.4	To Improve Product and Service Performance	19
3.5	Contributing to Organizational Learning	22
3.6	Summary	23
4	Six Sigma: Key Strategic Concepts	25
4.1	Six Sigma is Strategic	25
4.2	Six Sigma is About Customers	26



www.sylvania.com

**We do not reinvent
the wheel we reinvent
light.**

Fascinating lighting offers an infinite spectrum of possibilities: Innovative technologies and new markets provide both opportunities and challenges. An environment in which your expertise is in high demand. Enjoy the supportive working atmosphere within our global group and benefit from international career paths. Implement sustainable ideas in close cooperation with other specialists and contribute to influencing our future. Come and join us in reinventing light every day.

Light is OSRAM

**OSRAM
SYLVANIA** 



4.3	Six Sigma is About Variation	26
4.4	Six Sigma is About Process and Scientific Investigation	28
4.5	Six Sigma is About People and Learning Not Cost	28
4.6	Summary	29
5	Strategic Six Sigma	30
5.1	Introduction	30
5.2	Vision, Mission and Values	31
5.3	Strategic Objectives	33
5.3	Hoshin Kanri and Six Sigma	35
5.4	Summary	38
6	Customers	40
6.1	Introduction	40
6.2	Customer Satisfaction and Customer Value	40
6.3	Summary	43
7	Variation	45
7.1	Introduction	45
7.1	Special and Common Cause Variation	46
7.2	Process Capability	47
7.3	Summary	49



360°
thinking.

Deloitte.

Discover the truth at www.deloitte.ca/careers

© Deloitte & Touche LLP and affiliated entities.

8	Processes and Scientific Investigation	50
8.1	Introduction	50
8.2	Business Processes: The Reality	52
8.3	Scientific Investigation	53
8.4	Summary	54
9	People and Organizational Learning	55
9.1	Key Six Sigma Roles	55
9.2	Belt System Issues	57
9.3	People and Change	57
9.4	Organizational Learning	61
9.5	Summary	62
10	Sustainable Six Sigma Deployment	63
10.1	Deployment Model: Kotter	63
10.2	Deployment Logic: System of Profound Knowledge (SoPK)	64
10.3	Steps 1 to 3: Envisioning the Transformation	65
10.4	Steps 4 to 7: Enacting the Transformation	67
10.4	Step 8: Institutionalise the New System	70
10.5	Summary	70

SIMPLY CLEVER

ŠKODA



We will turn your CV into
an opportunity of a lifetime

Do you like cars? Would you like to be a part of a successful brand?
We will appreciate and reward both your enthusiasm and talent.
Send us your CV. You will be surprised where it can take you.

Send us your CV on
www.employerforlife.com



11	Six Sigma Projects: Key Concepts	71
11.1	Basic Statistical Concepts	71
11.2	Variation, the Normal Distribution, DPMO and Sigma Levels	73
11.3	The Scientific Method and the DMAIC Cycle	76
11.4	The Four Focuses of a Six Sigma Project	77
11.5	Process	78
11.5	People and Change	79
11.5	Summary	79
12	DMAIC	80
12.1	Introduction	80
12.2	The Define Stage	80
12.3	The Measure Stage	82
12.4	The Analyse Stage	84
12.5	The Improve Stage	85
12.6	The Control Stage	86
12.7	Summary	86
13	Customer Focus in DMAIC	87
13.1	Introduction	87
13.2	What Does the Customer Value?	87
13.3	What is the Value Stream?	90

I joined MITAS because
I wanted **real responsibility**

The Graduate Programme
for Engineers and Geoscientists
www.discovermitas.com



Month 16

I was a construction supervisor in the North Sea advising and helping foremen solve problems

Real work
International opportunities
Three work placements





13.4	What Design/Process Elements Affect Customer requirements?	91
13.5	Quality Function Deployment	91
13.6	Summary	98
14	Variability Reduction in DMAIC	99
14.1	Introduction	99
14.2	Building and Using Control Charts	100
14.3	Responding to Out of Control Conditions	110
14.4	Process Capability	115
14.5	Responding to Incapable Processes	118
14.6	Evaluating the Measurement System	119
14.7	Summary	123
15	Soft Aspects of DMAIC	125
15.1	Learning in and Between Projects	125
15.2	People in Improvement	126
15.3	Summary	128
16	Processes in DMAIC Projects	129
16.1	Introduction	129
16.2	Supplier-Input-Process-Output-Customer (SIPOC) Diagram	129
16.3	Process Flow Chart	129

ie business school

#1 EUROPEAN BUSINESS SCHOOL
FINANCIAL TIMES 2013

#gobeyond

MASTER IN MANAGEMENT

Because achieving your dreams is your greatest challenge. IE Business School's Master in Management taught in English, Spanish or bilingually, trains young high performance professionals at the beginning of their career through an innovative and stimulating program that will help them reach their full potential.

- Choose your area of specialization.
- Customize your master through the different options offered.
- Global Immersion Weeks in locations such as London, Silicon Valley or Shanghai.

Because you change, we change with you.

www.ie.edu/master-management | mim.admissions@ie.edu | f t in YouTube

16.4	Value Stream Mapping	130
16.5	Soft Systems Methodology	131
16.6	Summary	131
17	DMAIC in Service Organizations	132
17.1	Introduction	132
17.2	Service is Different	132
17.3	The Dimensions of Service Quality	133
17.3	Contribution of Six Sigma	134
17.4	Potential Modifications to Six Sigma in Service Environments	134
17.5	Summary	135
18	Successful DMAIC Projects	136
19	Example of a Six Sigma Project	137
19.1	Introduction	137
19.2	Project Background	137
19.3	Selection of a Quality Characteristic	137
19.4	Methodology	139
19.5	Summary	150
20	Quality by Design (for Six Sigma)	152
20.1	Introduction	152
20.2	The DFSS Process	154
20.3	The Voice of The Customer	155
20.4	Impact of Late Design Changes	160
20.5	Design for 'X'	161
20.6	DFSS Tools	162
20.7	Summary	162
21	Six Sigma: A Critique	163
21.1	Introduction	163
21.2	Accepted Strengths of Six Sigma	163
21.3	Reasons for Failure and Critical Success Factors	163
21.2	Inherent Conceptual Issues	167
21.3	The Future	170
21.4	Summary	171
22	References	173

1 Introduction

Six Sigma is one of the most important and popular developments in the quality field. It has saved huge amounts of money and improved the customer experience for a large number of organizations across the world, yet it is applied in an inconsistent and often reductive fashion in many companies. This has led to criticism in the literature and a number of abandoned implementations. This study guide is designed to provide an overview of the key elements, important historical context and current debates in the field of Six Sigma. It aims to give a coherent view of the underlying principles, and how these relate to practical application in a range of organizations as well as to other areas of study. The broad Quality Management context, within which Six Sigma fits, will not be explored in this book in detail. More information on this can be found in the companion guide: “Quality Management in the 21st Century” also available at Bookboon.com.

The guide flows from principles and background to more detailed consideration of Six Sigma as both a business level initiative and project-based improvement methodology. Due to the complexity of many of the issues addressed, it is possible to write much more on any single topic but I have tried to cover most of the key points in order to provide a foundation and further literature linked from the text allows the reader to investigate any topic in more depth if they wish. Finally, at the end of each chapter there are a number of questions for you to develop your thinking in the area.

2 Background and History

Although many proponents of Six Sigma stress the uniqueness of the approach, it is, in fact, part of a continuing evolution of thinking in what might broadly be called “Quality”. It is important to see Six Sigma within this wider context.

2.1 Development of Quality Thinking

Figure 2.1 indicates the new ideas which arrived in quality at various point in history. The advent of a new era does not necessarily mean that the practices and principles espoused by earlier eras died out; in fact many examples of craftsmanship or quality assurance can be found today. Nor is the beginning of each era meant to represent the first articulation of theories or approaches, but where they became mainstream. The bands indicate, broadly, times when those ideas were pre-eminent in the quality domain. This history is expanded upon in “Quality Management in the 21st Century” also available at Bookboon.com.



Figure 2.1. A Quality Timeline

2.1.1 Key Building Blocks

Standardization was really the first important building block, developing the idea that consistency was important, in both products and processes. This developed into a wider understanding of variation and its impact. The cost of quality movement alerted managers to the direct linkage of improved quality to the bottom line, while the TQM movement brought focus onto Quality as a strategic priority and introduced team-working, leadership and involvement of the workforce as key issues.

2.2 Six Sigma: The Next Evolution

There are those who will tell you that Six Sigma is radical and new. The fact is that Six Sigma (done properly) is a recognisable evolution of TQM. De Mast (2006) sees it as an on-going phase in the evolution of methods and approaches for quality and efficiency improvement. Six Sigma can be seen as the accumulation of principles and practices developed in management statistics and quality engineering, all of which matured significantly over the course of the Twentieth Century.

The Six Sigma approach was first developed in the late 1980s within a mass manufacturing environment in Motorola (Harry, 1998) as they struggled to meet demanding quality targets on complex manufactured products; and become widely known when GE adopted it in the mid-90s (Folaron and Morgan, 2003; Thawani, 2004) when, arguably, it evolved from being a process improvement methodology to a broader, companywide philosophy. Both companies still consider Six Sigma as the basis for their on-going strategic improvement approach. Since the 1980s Six Sigma has become one of the most popular improvement initiatives; widely implemented around the world in a wide range of sectors (by companies such as Boeing, DuPont, Toshiba, Seagate, Allied Signal, Kodak, Honeywell, Texas Instruments, Sony, Bombardier, Lockheed Martin) that all declared considerable financial savings (Harry, 1998; Antony and Banuelas, 2001; Kwak and Anbari, 2006). Other benefits claimed for Six Sigma include increased stock price, improved processes and products quality, shorter cycle times, improved design and increased customer satisfaction (Lee, 2002; McAdam et al, 2005).

Six Sigma has undergone a considerable evolution since the early manifestations (Folaron and Morgan, 2003; Abramowich, 2005). Initially it was a quality measurement approach based on statistical principles. Then it transformed to a disciplined processes improvement technique (based on reducing variation within the system with the help of a number of statistical tools). For example, Snee (1999) defined Six Sigma as an 'approach that seeks to find and eliminate causes of mistakes or defects in business processes by focusing on outputs that are critical importance to customers'. The definition given in 1999 by Harry and Schroeder (1999) also defines Six Sigma as 'a disciplined method of using extremely rigorous data gathering and statistical analysis to pinpoint sources of errors and ways of eliminating them'.

In its current incarnation it is commonly presented as 'a breakthrough strategy' and even holistic quality philosophy (Pande, 2002; Eckes, 2001). It is now generally accepted that Six Sigma is applicable to various environments such as service, transactions or software industry regardless the size of the business (Pande, 2002; Lee, 2002) and being adapted Six Sigma may lead to nearly perfect products and services. Moreover, Six Sigma is widening its areas of application very rapidly and there are examples of applying Six Sigma to predicting the probability of a company bankruptcy (Neagu and Hoerl, 2005) or finding opportunities for growth (Abramowich, 2005).

In the past five years, hundreds of organizations have indicated their interest in making Six Sigma their management philosophy of choice. While many of the businesses attempting to implement Six Sigma are well intentioned and want to implement Six Sigma properly just as General Electric did, there are also those impatient executives who now look on Six Sigma in the same way as they look on downsizing. This quick-fix approach to Six Sigma is a sure path to the same short-term results that prevent long-term profitability.

It is worth noting that the evolution of Six Sigma is continuing with, for example, the integration of Lean Principles, development of a product/service variant (Design for Six Sigma) amongst others (De Mast, 2006).

2.3 Definition of Six Sigma

Before we study the subject of Six Sigma in any depth, we need to define the term. Perhaps unusually, Six Sigma has 3 distinct elements to its definition:

- **A Measure:** A statistical definition of how far a process deviates from perfection.
- **A Target:** 3.4 defects per million opportunities.
- **A Philosophy:** A long term business strategy focused on the reduction of cost through the reduction of variability in products and processes.

Accordingly, it is defined in a variety of ways by several authors, but for the purposes of these notes the definition from Pande et al (2000) focused on the more comprehensive philosophy of Six Sigma will be used:

“A comprehensive and flexible system for achieving, sustaining and maximising business success. Six Sigma is uniquely driven by close understanding of customer needs, disciplined use of facts, data, and statistical analysis, and diligent attention to managing, improving, and reinventing business processes.”

A strong structure and clear alignment to organisational goals (particularly financial) are a key part of the Six Sigma approach as defined by Eckes (2001). Leadership is provided by a team of Champions – Senior Champion, Deployment Champion, Project Champion at corporate, unit and department levels respectively supported by a team of experts. The experts are referred to as Black Belts (who work full time on projects at process level to solve critical problems and achieve bottom-line results) and Master Black Belts (who provide mentoring, training and expert support to the Black Belts). Ingle and Roe (2001) note that that this significant organisational structure can range from 4000 Black Belts in a corporate population of 340,000 in GE to 120 Black Belts in a corporate population of 100,000 in Motorola. Black Belt training is typically 16 –20 weeks in GE and a year in Motorola (Ingle and Roe, 2001), although both are interspersed with projects that bring value to the organisation.

2.4 Summary

This section gives a brief introduction to the history of Six Sigma and recognises it as an evolution in the on-going development of thinking in the area broadly described as “Quality” (involving as it does developments in quality engineering, statistics and management theory and practice). A definition reflecting the current state of Six Sigma development is suggested and it is recognised that the current status quo is unlikely to be permanent.

3 Why Six Sigma?

3.1 Introduction

There can be few initiatives which have been trumpeted as loudly as Six Sigma; few where the claims have been so extravagant; and few which divide the quality community so completely. While this section does not, indeed cannot, propose to investigate fully the evidence supporting the self-declared results of major corporations it does attempt to clarify the level of expectation placed upon Six Sigma programmes. The sub-sections below address the potential answers to the question; 'Why Six Sigma?', and draws on the work of Henderson and Evans (2000) who investigated the GE experience in some detail.

3.2 To Improve Financial Performance and Profitability

Bob Galvin (then Motorola president) was reputed to be the man who began the Six Sigma revolution by issuing a 'Six Sigma Challenge' in 1987 for a ten-fold improvement in performance in every 2 year period (Goetsch and Davis, 2010). Over the 10 years following the call, Motorola claims to have saved \$414 billion, increased sales by a factor of 5 and increased profits by 20% each year (Pande et al, 2000). GE declared that for 3 years (1996-1998) Six Sigma related savings were about \$2bn; Honeywell stated that its annual Six Sigma savings as around \$600-700 million; and Dow Chemicals claimed \$2.2bn of Six Sigma financial benefits (Lee, 2002).

It is often stated that a 'typical' company operates around the 3 sigma level (Murphy, 1998) and there have been a number of attempts to quantify the financial effects of varying sigma levels. Klefsjo et al (2001) suggest that for Six Sigma performance levels the cost of poor quality would be less than 1percent of sales, while for 5 Sigma that would rise to 5-15 per cent, at 4 Sigma the cost would be 15-15 per cent and at 3 Sigma levels it would equate to around 25-40 per cent of sales.

There are countless other (admittedly self-reported and largely unverified) claims for the financial benefits of Six Sigma; with the savings achieved due to decrease in operational costs, reduction in scrap and rework rates, etc. (Lee, 2002). The two important ideas which support the logic of this are 'Cost of Poor Quality' and 'Waste', both of these are explored briefly below and in more detail in "Quality management in the 21st Century" also available on Bookboon.com.

3.2.1 Cost of Poor Quality

Perhaps the most obvious tangible benefit of quality improvement is the reduction of costs associated with non-quality. If we have to throw a product away because we have made an error in its manufacture, it is clear that there is an immediate financial impact as all the costs sunk into the product are lost. Similarly, doing an incorrect operation over again absorbs cost (operator time, power, additional materials, etc.).

Although anyone who works in an organization will be familiar with many examples of both of these issues, business accounting systems are not set up to capture these costs. Traditional accounting approaches are designed to track the inflow and outflow of money in an organization (and, by extension, to product lines or departments). There is little emphasis on whether the money in the department is spent effectively. For example, budget reporting will recognise that overtime cost £100,000 this month, but will not differentiate between time used to respond to short lead-time customer demand and time spent correcting errors. Even when it does highlight a cost of poor quality, perhaps in an over-budget condition in material spend, it will give no clear indication of where exactly the over-spend occurred. Table 3.1 shows Fiegenbaum's Prevention-Appraisal-Failure (P-A-F) model of costs of poor quality, although there are others.

Cost Area	Cost of Control (Cost of Conformance)		Cost of Failure of Control (Cost of Non-Conformance)	
	Prevention Costs	Appraisal Costs	Internal Failure Costs	External Failure Costs
Description	Arise from efforts to keep defects from occurring at all	Arise from detecting defects via test, audit, inspection	Arise from defects caught internally and dealt with by discarding or repairing the affected items	Arise from defects that actually reach the final customer.
Examples	Quality planning Statistical Process Control Quality training and workforce development Product design verification Market research	Test and inspection of purchased materials Inspection Testing Quality audit	Scrap Rework costs Management of rework systems Rejection paperwork	Warranty costs Out of warranty complaints Product recall Product liability claims Loss of customer goodwill

Table 3.1. Cost of Quality types and examples (adapted from Feigenbaum, 1961)

“I studied English for 16 years but...
 ...I finally learned to speak it in just six lessons”
 Jane, Chinese architect

ENGLISH OUT THERE

Click to hear me talking before and after my unique course download



The lack of clarity of the cost of poor quality in organizations led to a lack of focus on improvement for many years. It was only with the advent of the “Cost of Quality” approach in the 1950’s (Defoe and Juran, 2010) that organizations had a financial tool to assess the costs associated with quality failures and thus focus on the most important areas for improvement. Six Sigma directly assesses costs of poor quality on a project by project basis, providing clear motivation for improvement and an indication of expected gains.

The basic logic is that a relatively small increase in spending on prevention activities will deliver a more than compensating reduction in appraisal and failure costs (see figure 3.1)

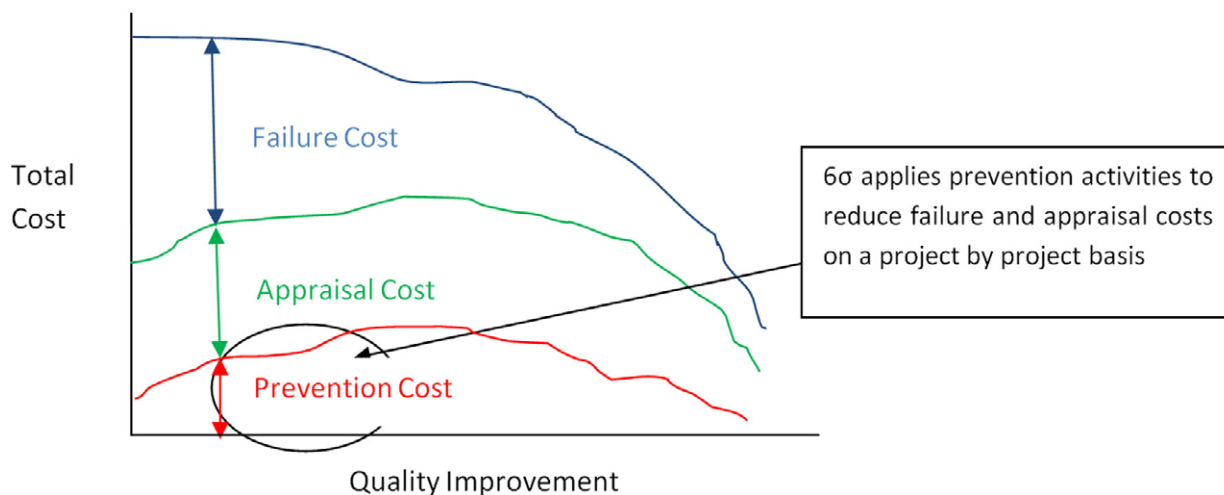

Figure 3.1. Quality costs during improvement (adapted from Businessballs.com, 2011)

3.2.2 Waste

Cost of Quality models are certainly helpful in generating momentum in the quality improvement movement, however, they are, at best, a partial view of the economic benefits. The focus on failure neglects aspects of waste which relate to flow and efficiency as opposed to accuracy. For example, an operator having to wait for products from a previous process would not register on the P-A-F model, but would clearly have an impact on the costs of the organization.

The concept of waste is fairly generic in nature and has been around for a long time. Many organisations refer to ‘non-value added activities’ and ‘process waste’. However, these are rather broad terms and, whilst it is easy to agree that waste is bad and should be eradicated (or at least reduced) it does not much help in the process of improvement. The Seven Wastes were identified by Ohno as part of the Toyota Production System (Ohno, 1988) and have since been widely applied to process improvement, becoming particularly associated with the principles of lean manufacturing.

It can readily be seen that some of the costs associated with these activities would fit neatly into the Cost Of quality models discussed in the previous section, but that some would be transparent to that system. Table 3.2 indicates the kind of financial impacts that might be caused by the types of waste. Those which would not be picked up by a Cost of Quality measurement system are in bold italics.

Type of Waste	Potential Associated Costs
Waiting	<i>Labour cost associated with idle time.</i> <i>Value of lost production (if units are lost) or cost of overtime if this has to be worked to catch up.</i> Cost of late delivery if overall process time affected.
Correction	Rework cost (direct and overhead if applicable). Cost of delays (as above). Inspection costs. Disposal costs if correction is not possible. Paperwork system costs.
Over-Production	<i>Storage costs (inc. handling costs & capital tied up).</i> <i>Extra material costs if excess cannot be sold.</i> Deterioration/depreciation costs (if appropriate). Cost of delays (as above).
Processing	Additional processing costs (direct and overhead if applicable). Transportation costs.
Conveyance	<i>Additional cost of unnecessary conveyance system.</i> <i>Cost of late delivery if overall process time affected.</i> Deterioration/damage costs.
Inventory	<i>Storage costs (inc. handling costs & capital tied up).</i> <i>Deterioration/depreciation costs (if appropriate).</i> <i>Obsolescence costs (if appropriate).</i>
Motion	<i>Additional labour costs (including absenteeism).</i>

Table 3.2. Types of waste and associated costs

This type of approach allows for a clear identification of potential cost savings, whilst also allowing for the improvement and ‘what to do differently’ elements of the waste based approach.

The impressive financial gains associated with Six Sigma certainly account for much of its popularity, but on the downside may also be responsible for the ‘quick fix’ mentality which has characterised at least some of the applications.

3.3 To be Responsive to, and Focused on, Customers

3.3.1 Product Out vs. Market In

We often consider ourselves ‘expert’ in our customers’ requirements. We, after all, have been in this business for a long time; we have much more experience than the typical customer, who may have only bought a few of our products. We are technically much more au fait with the product, and with those of our competitors.

It is easy to see how this logic leads us to take a rather patronising attitude to customers who either don’t really know what they want, or don’t understand the complexities of the product. Anyone who has been on the end of a customer service discussion where they have been told that they must have been misusing the product, or that it was not designed for the circumstances described, will recognise this mentality.

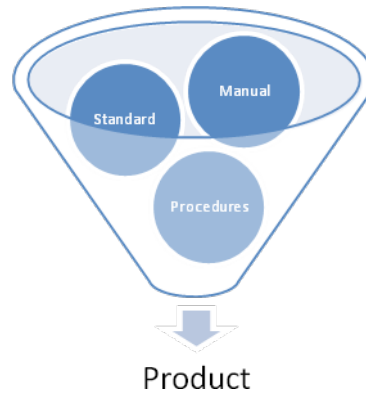

Figure 3.2. Product Out Concept

This is known as the 'Product Out' concept (Shiba, Graham and Walden, 1993) where the focus is on working to specification or instruction and the product is 'pushed' from the company to the customer. The problem with a product out focus is that it is slow to respond to changing markets and customer requirements (an ever more significant aspect of the world today). The 'Market-In' approach (Shiba, Graham and Walden, 1993) allows for a much more responsive system and places a requirement on the organization to go and find out the customer requirements.

Customers may not be expert in the technicalities of the product, but they do know what they need the product to do for them.

Excellent Economics and Business programmes at:



**university of
 groningen**



**“The perfect start
 of a successful,
 international career.”**

CLICK HERE
 to discover why both socially
 and academically the University
 of Groningen is one of the best
 places for a student to be

www.rug.nl/feb/education



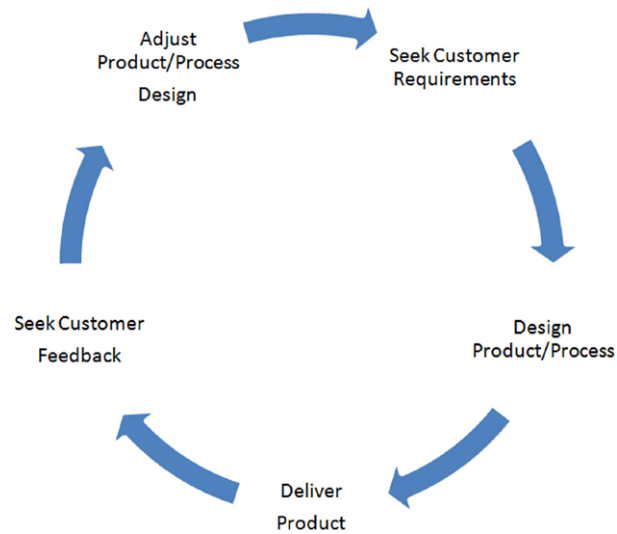

Figure 3.3. Market In Concept

The Six Sigma initiative attempts to deploy the voice of the customer through the processes of the organization. Improvement projects should be as much about customer value as they are about financial benefit (Schroeder et al, 2008). Henderson and Evans (2000) note evidence that in GE Aircraft Engines division the Six Sigma programme directed the business to look at the needs of the customer and focus on their priorities. Schroeder et al (2008) notes that some service organizations prefer to track customer satisfaction, rather than savings.

3.4 To Improve Product and Service Performance

Clearly, a reduction in defects will be helpful to our customers in that it will reduce the likelihood that and defects will escape detection and affect the final customer. However, in looking to reduce variation in product and service outcomes Six Sigma takes a step beyond the out-moded goalpost approach to quality and recognises the deeper truth of the Taguchi Loss Function (Taguchi, 1986).

3.4.1 Taguchi Loss Function and Customer Satisfaction

The Taguchi Loss Function (Taguchi, 1986) shows how increasing capability (i.e. reducing product variation in relation to the tolerance band) can improve customer satisfaction even if all products already meet specification. The Loss Function as defined by Taguchi is basically a challenge to the traditional ideas on what constitutes acceptable quality for manufactured products. Figure 3.4 contrasts Taguchi's Loss Function and the traditional tolerance (also known as specification)-based approach to product quality.

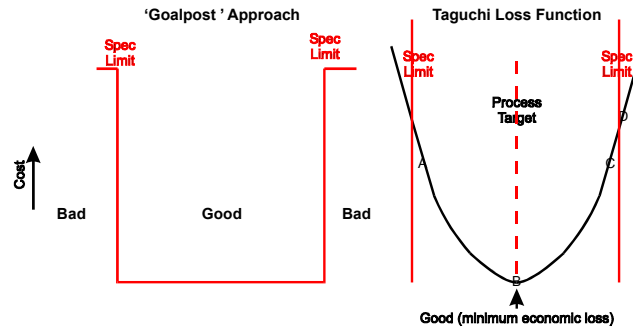

Figure 3.4. Loss function vs. tolerancing.

Traditional thinking is that any product that falls inside the tolerance limits is “good”. The unspoken assumption here is that they are equally good and that no cost is incurred. Following the logic through we can see that any product falling outside the limits is bad and a cost equivalent to the full cost of producing that product is incurred (often referred to as the scrap cost). In this simple scenario we have assumed that reworking the product is either not possible or uneconomic. Again, the hidden implication is that all products outside the limits are equally bad.

The usual derivation of tolerances further throws this attitude into doubt. They are usually based upon what was done last time or the draughtsman’s ‘best guess’. There also exists an element of barter in the generally adversarial relationship between design and production with designers wanting to tie production down to extremely tight tolerances and manufacturing wanting to be able to drive a bus through them. Seen in this light tolerances can be viewed as, at best, somewhat arbitrary. In any case, the specification limits will always be what is acceptable, rather than what the customer or designer wants. In most cases the ideal will be all products exactly on target; this will mean the design works exactly as intended. However, this is recognised as unrealistic, hence the use of specifications.

Taguchi states that to regard the transition from good to bad as a step change is not logical. He contends that, provided the nominal has been specified correctly, any deviation from this target value will have a detrimental effect on the performance of the product and will therefore cause an overall “loss to society”. This concept is probably one of the more esoteric of Taguchi’s ideas. A good example may be to consider the thickness of a polythene sheet used by farmers to protect crops; if the sheet thickness is low (but within tolerance) it may tear more easily and allow the weather to damage the crops. The costs generated by this failure will be outside the company but very real. Firstly, farmers will incur additional replacement costs; secondly, the reduced crop yield will increase the price in the marketplace, a loss borne by all society.

In many cases it is easier to think of the “loss to society” in terms of a long-term loss to the company. The reduced performance of the product caused by non-optimal parts will cause relative dissatisfaction in customers who will, given sufficient stimulus, take their trade elsewhere. The further from optimum performance we deviate the quicker will be their defection.

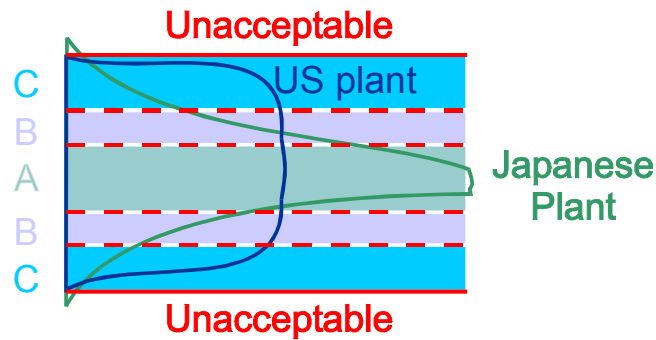

Figure 3.5. Sony TV production.

Figure 3.5 is an illustration of the loss function as a long-term loss to the company, and appeared in a Japanese newspaper called “The Asahi” in 1979. The article discussed the preference of American consumers for television sets built by Sony in Japan over those built at an identical plant in the USA. The key performance characteristic is colour density. The ‘A’ band represents excellent colour density; the ‘B’ band good colour density and the ‘C’ band acceptable colour density. Outside of the limits of the ‘C’ bands colour density is deemed unacceptable and the TV is considered a reject.

Clearly from the figure, Sony Japan was producing defects whilst the American plant was not. However, the key fact is that the chances of having an ‘A’ or ‘B’ grade TV from the Japanese plant was much greater than the American one where the odds of getting any grade were roughly similar. The “in tolerance is OK” attitude was costing a lot of sales for the American plant. The Taguchi belief that variation from the nominal is expensive seems much closer to the truth in this case.

American online

LIGS University

is currently enrolling in the
Interactive Online **BBA, MBA, MSc,**
DBA and PhD programs:

- ▶ enroll **by September 30th, 2014** and
- ▶ **save up to 16%** on the tuition!
- ▶ pay in 10 installments / 2 years
- ▶ Interactive **Online** education
- ▶ visit www.ligsuniversity.com to find out more!

Note: LIGS University is not accredited by any nationally recognized accrediting agency listed by the US Secretary of Education. More info [here](#).





Taguchi (1986) states that the loss function takes the quadratic form shown above for all “nominal the best” type characteristics and the appropriate half of that shape for “bigger the better” and “smaller the better” features. Whether this is in fact strictly the case is debatable. However the principle that deviation from the target is expensive regardless of tolerances and that the rate of deterioration of the situation increases with distance from the target is sensible. In fact, as Wheeler (1995) notes, this effectively creates a new definition of world class quality, one with capability at its heart. No longer is in specification sufficient, the new definition is:

“On target with minimum variation”

3.5 Contributing to Organizational Learning

Six Sigma is inherently a learning process (Wiklund and Wiklund, 2002) and, as such, has the potential to contribute to organizational learning. This can be seen in the organizational learning cycle (Dixon, 1994) shown below:

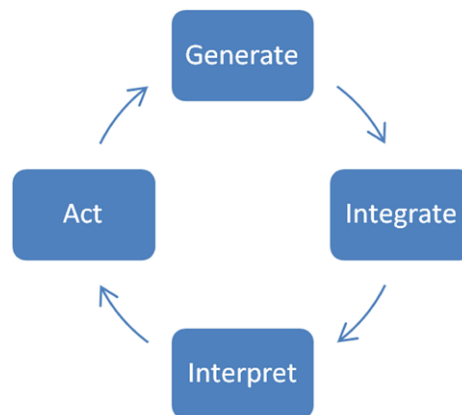

Figure 3.6. The Organizational Learning Cycle (Dixon, 1994)

- Experiences need to be spread throughout the organization in order to *generate* learning.
- Reflection, requires the *integration* of the experience into an organizational context.
- To create shared concepts and mental models collective *interpretation* of the contextualised experience takes place.
- *Action* is required to test the analysis, which underpins the interpretation.

It is clear that a Six Sigma improvement project generates learning through investigation of a process, integrates that with organizational goals and specific knowledge of statistics, etc. and interprets this to generate improvements through action. At an organizational level sharing of good practice of projects lifts the learning to a higher level. De Mast (2006) describes the ability to facilitate people at all levels in an organization to learn how processes work and to put this new knowledge to effective use as the core capability that Six Sigma can bring to an organization. As a meta-capability (one which spans all domains) this offers much more potential for long-term competitive advantage than the specific project-based improvements in operational efficiency.

The impact of learning on an organization is to increase organizational capability by equipping it with a better understanding of processes and outcomes and to allow for the generation of new knowledge and innovation which improves the capability of the organization to respond to change and new challenges. This is, in fact, a higher order effect than simply improving processes and generates benefits including (Pedler et al, 1997; McHugh et al, 1998):

- Maintaining levels of innovation and remaining competitive
- Being better placed to respond to external pressures
- Having the knowledge to better link resources to customer needs
- Improving quality of outputs at all levels
- Improving corporate image by becoming more people oriented
- Increasing the pace of change within the organization

In fact, organizational learning has been discussed as vital to the survival of organizations in an increasingly volatile world.

“In times of change the learners will inherit the earth, while the knowers will find themselves beautifully equipped to deal with a world that no longer exists”

Eric Hoffer

Even though it is a higher order endeavour this is, sadly, the least frequently cited reason for exploring Six Sigma.

3.6 Summary

Six Sigma has the potential to contribute to an organization in a range of ways; the common approach of focusing on financial measures alone misses some of the more important but less easily measurable aspects.

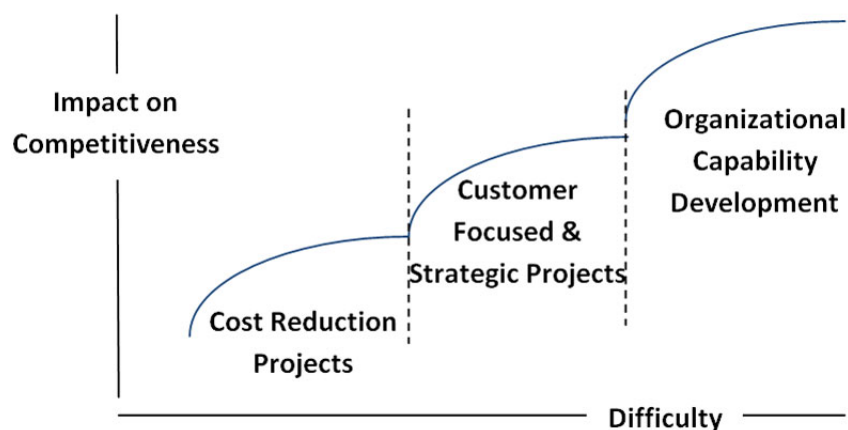

Figure 3.7. Impact on competitiveness versus difficulty for various Six Sigma approaches

Review & Discussion Questions:

- 1. What are the advantages of considering waste and quantifying cost from this basis, rather than just using the P-A-F model?*
- 2. What are the management implications of defining quality as on-target with minimum variation, rather than just within specification?*
- 3. Why is organizational learning considered a higher goal for Six Sigma?*



.....Alcatel-Lucent 

www.alcatel-lucent.com/careers

What if you could build your future and create the future?

One generation's transformation is the next's status quo. In the near future, people may soon think it's strange that devices ever had to be "plugged in." To obtain that status, there needs to be "The Shift".



4 Six Sigma: Key Strategic Concepts

There are a number of important concepts which have come together in the modern Six Sigma philosophy. These are summarised in this chapter in order to provide a sound basis for the discussions in later chapters.

4.1 Six Sigma is Strategic

Historically, initiatives centred on quality have frequently been undertaken at a tactical level, focused on projects or cost reduction. Eckes (2001), amongst others makes the point that Six Sigma activities must be supported by processes and structures to ensure they move business objectives forward. Knowles et al (2005) suggest that the DMAIC cycle should be replaced by two linked cycles, one setting strategic objectives, from which project definitions are developed and followed through with the outcomes feeding back into the strategic cycle to understand the contribution made to strategic objectives and what that means at a strategic level.

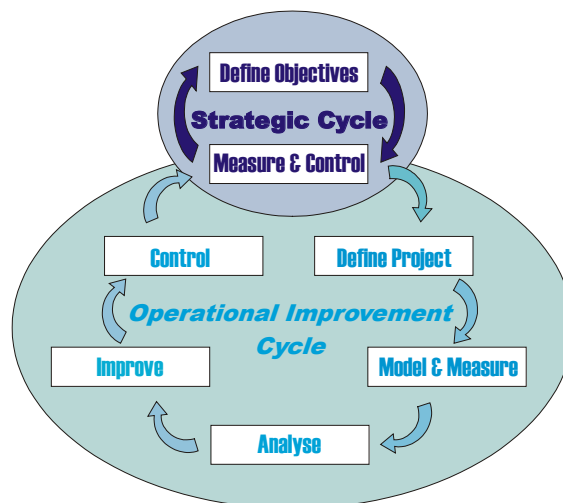

Figure 4.1. The Supply Chain Conceptual Improvement Model (Adapted from Knowles et al, 2005)

Although senior management may profess their interest and support the practical evidence suggests that most quality related activities were delegated downwards to quality managers and that, despite the evidence of benefit, they were never seen as central. Six Sigma has moved the focus back to quality as a strategic initiative, perhaps most famously in the person of Jack Welch who not only declared that Six Sigma was central to the way he expected GE to do business and based 40% of senior management bonuses on achievement of Six Sigma targets but also required that (as he did) senior management (Henderson and Evans, 2000):

- Personally spend time in each Six Sigma training wave talking to candidates and answering their questions.
- Drop in on Six Sigma reviews (held weekly and monthly).
- Make site visits to observe first-hand the integration of Six Sigma into business culture and operations.
- Monitor progress through weekly summary reports and monthly reviews with the Master Black Belt team.

By talking in the language of senior management (money) and by requiring hands-on commitment and direct involvement Six Sigma creates a much stronger cultural impact.

4.2 Six Sigma is About Customers

Shiba, et al. (1993) note the difference between the traditional ‘Product-Out’ concept, where the company works to a set of standards and a ‘good’ product is one which conforms to the company standards, and the ‘Market-In’ concept where the focus is on satisfying the customer. As long as the standards are aligned with the customer requirements, it may be argued, there is no conflict in these two approaches. However, the difference lies in the behavioural implications. A ‘Product-Out’ mentality will lead to adherence to standard despite unhappy customers – “It meets our standard so it must be OK”. This approach will be compromised with an unexpected change to customer tolerances, and has led to the demise of many organizations when a better alternative hits the market causing customers to suddenly expect more of the product.

An example might be the advent of smart phones and the problems Nokia have experienced (search the web for the Nokia “burning platforms” memo) in their market share since Apple launched the iPhone, and radically changed the market. Playing catch-up when the market changes suddenly is very difficult and expensive, as Nokia has discovered. A ‘Market-In’ approach encourages the active engagement with customers which makes it less likely that companies will stick to outmoded specifications, or miss coming trends for too long.

There is also a degree of arrogance which can set in with the ‘Product-Out’ mentality. An assumption (often expressed by designers) that the customer does not know what they want. Whether this is true or not is largely a moot point. A quote attributed to Ford is often used to illustrate this idea:

“If I had asked my customers what they wanted, they would have said a faster horse.”

Of course this merely misunderstands the idea of customer focus. What customers can (and should) be asked for is what they need, or what they would value –in this case faster movement from A to B- rather than how we should deliver the requirement – the horse versus internal combustion engine. This is not to say that at times an innovation cannot create a hitherto non-existent need, simply to say that this happens fewer times than is perhaps suggested. Did Apple truly create a new set of customer needs, or simply respond innovatively to emerging trends of mobile computing?

Six Sigma recognises the value of customers to the organization and focuses on creating value for the customer. Six Sigma initiatives which focus on cost reduction miss the point that what delivers long term profitability are happy customers, even more so than lower costs. A good Six Sigma project focuses on the customer rather than short term financial gain (Anderson et al, 2006).

4.3 Six Sigma is About Variation

Section 3.4 covers the key issues in this section. Six Sigma recognises that variation in products generates problems not only in terms of defects (the famous Defects Per Million Opportunities metric is perhaps a little misleading in this regard) but also in terms of adding cost and reducing customer satisfaction – and future revenues. The Taguchi Loss Function shows this effect elegantly, but a few examples might help to illustrate the issues.

- Variation in component parts can lead to issues in assembly where fits vary to a significant degree. Time can be taken up with adjustment and ‘fitting’ as opposed to simple assembly. The extreme case is ‘selective fitting’ where components have to be selected to fit together adding time to the operation.
- Inconsistent performance of products which are ostensibly the same causes customer dissatisfaction leading to reduced future purchases due to the impact on reputation from the few poorly performing products.

Variation in Gearbox Components

Back in the 1980’s Ford had a joint venture with Mazda to produce a car called the Batavia. One aspect of the collaboration was that both companies produced gearboxes. After a short time in the field most customers preferred the Japanese gearboxes which were reputedly smoother, quieter and easier to use. When Ford investigated the two products they found that although the Ford gearbox components were all in tolerance, the Mazda components were much closer to target and exhibited much less variation.

Although both gearboxes met the tolerances, customers were migrating to the better performance delivered by the more consistent product.

Based on “A Prophet Unheard”, BBC Video (1992)



Maastricht University

Leading in Learning!

**Join the best at
the Maastricht University
School of Business and
Economics!**

Top master’s programmes

- 33rd place Financial Times worldwide ranking: MSc International Business
- 1st place: MSc International Business
- 1st place: MSc Financial Economics
- 2nd place: MSc Management of Learning
- 2nd place: MSc Economics
- 2nd place: MSc Econometrics and Operations Research
- 2nd place: MSc Global Supply Chain Management and Change

Sources: Keuzegids Master ranking 2013; Elsevier ‘Beste Studies’ ranking 2012; Financial Times Global Masters in Management ranking 2012

**Maastricht
University is
the best specialist
university in the
Netherlands
(Elsevier)**

**Visit us and find out why we are the best!
Master’s Open Day: 22 February 2014**

www.mastersopenday.nl



4.4 Six Sigma is About Process and Scientific Investigation

Eckes (2001) suggests one of the key aspects of Six Sigma is that it moves an organization towards managing with facts and data, too often in the past things have been done on the whim of a leader. The heart of Six Sigma is in the scientific method as exemplified by this practical model, provided by Process Management International (Gillet and Seddon, 2009).

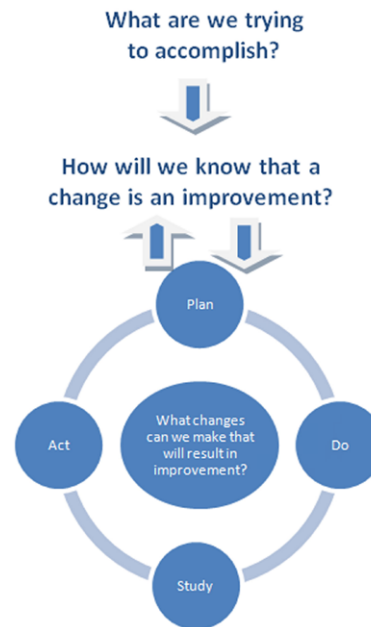

Figure 4.2. The three question model (Gillet and Seddon, 2009)

We need to begin with a goal and a clear understanding of how we will know when we have achieved it; then develop a plan as to how the goal might be achieved; the plan needs then to be enacted and the results (good and bad) observed. The analysis of these results (and our understanding of the causes) then leads us to act to modify our original plan, which brings us back to the start of the cycle and a test to see if we have achieved our goal before respinning the wheel if required.

4.5 Six Sigma is About People and Learning Not Cost

Eckes (2001) identifies culture as the most important (and most often forgotten) component of successful Six Sigma implementations. One of the keys to Six Sigma success at GE was the fact that, through activities such as the ‘workout’ process, Jack Welch set out to turn it into a learning organization before implementing Six Sigma. Welch himself is on record as seeing this as a vital precursor to Six Sigma, but as a much more complicated, difficult and less immediately accessible concept many consultants and organizations have air-brushed it out of the implementation process.

Without the active acceptance of the vast majority of the organization Six Sigma will never deliver its potential. Many companies fall into the trap of seeing resistance to change as problematic, rather than natural. The focus on overcoming resistance – seeing those who resist as a problem in effect – exacerbates the potential ‘them and us’ attitudes of the Six Sigma evangelist. If you see life in this binary fashion those outside the Six Sigma cadre will, at best, be ambivalent and at worst hostile. Inclusivity is the key at both strategic and project levels.

The first thing in almost every text book or article on Six Sigma is a list of financial benefits and impressively large savings (yes, I know I have done it too!). Whilst this is great for generating enthusiasm it represents one of the dangers to successful implementation. It has led to many organization implementing Six Sigma as a cost reduction initiative; ironically, as with happiness the more single-minded you are in pursuing cost reduction the less likely you are to achieve it in the long run.

4.6 Summary

The importance of this section is in the recognition that, in Six Sigma financial benefit is how you keep score and not the principal focus. Benefits come from a strategic engagement with quality principles, a scientific process focus, involvement and empowerment of the people in the organization and a focus on learning. Get these things right and the benefits will follow.

Review & Discussion Questions:

1. *Briefly critique the idea that customers are not best equipped to set the agenda for new product design.*
2. *Why is important to link individual projects to company strategy?*
3. *What benefit do Gillett and Seddon's additions to the PDSA cycle bring?*

5 Strategic Six Sigma

5.1 Introduction

In order to be effectively implemented, Six Sigma needs to be treated as a strategic priority. To understand what this means we need to define some terms:

- **Strategy:** Is a plan of action to achieve organizational goals, usually related to performance in the market place.
- **Strategic Management:** is the development, deployment and execution of strategic plans. It involves the development of organizational mission, vision, values and goals; the development of policies and plans, their execution and evaluation.

Six Sigma has often been used effectively as a tactical approach to address some of the levers of competition. This would mean reductions in cost or improvements in the quality of product or service delivered to the customer (effectively reduction in DPMO and variation in Critical to Quality aspects of the product or service). However, the strategic potential is far greater, strategically Six Sigma has the potential to help organizations develop what Ulrich and Lake (1991) called “Organizational Capability”. They argue that traditional sources of competitive advantage revolving round marketing capability, technological capability and financial capability are relatively transient and easy to copy. Organizational Capability however allows an organization to change and adapt as required by the changing world. The four key areas are:



> **Apply now**

REDEFINE YOUR FUTURE
**AXA GLOBAL GRADUATE
PROGRAM 2015**

redefining / standards 

agence eds - © Photonistop



- Leadership
- Capacity for learning and improvement
- Tacit knowledge and skills
- Mind-set and organizational culture

When Six Sigma is pursued strategically these are the things which are addressed.

5.2 Vision, Mission and Values

5.2.1 Vision

Corporate vision is essentially a tone setting idea, which is designed to align and inspire the stakeholders in an organization (principally and crucially those who work for it). It should be concise, easily understood and stirring. Vision statements vary in length and content. One of the best known was the vision statement for Fuji Film:

“Kill Kodak”

It can be seen to fulfil all the requirements above in two words. Vision statements which are this succinct are rare, but this should be the aspiration. Below are further interesting examples:

“Democratize the automobile” Ford Motor Company (1900s)

“To be the number one athletic company in the world” Nike

“To make people happy” Walt Disney Corporation

“Become the company most known for changing the worldwide poor quality image of Japanese products” Sony (1950s)

Again, they capture an inspiring vision for the organization at the time, of course, vision can change over time. The vision for GE set by Jack Welch was:

“Become the most competitive company in the world by being number one or number two in every business in which we compete”

Note that there is no mention of Six Sigma. The vision statement is what we need to achieve, not how we plan to achieve it.

5.2.2 Mission

Mission statements add detail to the vision statement. It captures who the organization is and what it will do to achieve its vision. Examples are:

“Google’s mission is to organize the world’s information and make it universally accessible and useful” Google

“McDonald’s vision is to be the world’s best quick service restaurant experience. Being the best means providing outstanding quality, service, cleanliness, and value, so that we make every customer in every restaurant smile” McDonalds

“The Walt Disney Company’s objective is to be one of the world’s leading producers and providers of entertainment and information, using its portfolio of brands to differentiate its content, services and consumer products. The company’s primary financial goals are to maximize earnings and cash flow, and to allocate capital profitability toward growth initiatives that will drive long-term shareholder value.” Walt Disney Corporation

Leaving aside any personal views on the organizations concerned it can be seen that these develop the vision to suggest more practical aspects of strategy and set boundaries, be they industry sector, geographic, or temporal. GE do not have a mission statement as such, but they use what they describe as values (although they fall somewhere between values and a mission statement:

“Imagine, solve, build and lead.”

5.2.3 Values

Alongside vision and mission it is important to develop organizational values. These are the things in which the organization espouses belief. They are an indication of the way in which missions will be delivered. Values add nuance to vision and mission statements, but are actually more enduring than either; while external circumstances may affect the vision or mission of an organization the values should be unchanged in most circumstances.

Southwest Airlines: Values in Action

Southwest Airlines places relationships at the heart of its business values. Relationships with its people; with its customers; and with its shareholders (very definitely in that order). When faced with the post 9-11 world of vastly reduced passenger numbers and squeezed margins most airlines, understandably, tackled cost by laying off staff. This was an option open to Southwest Airlines, but they deemed it contrary to their values (even though they were similarly stated to those of many other airlines). They refused to lay off a single member of staff, instead engaging them in cost saving activities which resulted in improved fuel efficiencies amongst other things.

This counter-intuitive, but value based decision allowed them to make a profit every quarter while the rest of the industry lost \$22 million over the next 3 years.

Based on Leavenworth, S. (2011)

Values need to be properly respected in an organization. If the espoused values are not supported by the corporate behaviours they will be unconvincing to the staff of the organization, and they lose all relevance and value. In fact, they can become counter-productive, serving as a parody of the actual behaviours and a focus for staff resentment. For example, many organizations claim that ‘people are our most important asset, but in companies where the actual experience falls short of this ideal such statements are viewed with bitter irony. On dishonest values statements, noted leadership author Patrick Lencioni points out that:

“Far from being harmless, as some executives assume, they’re often highly destructive. Empty values statements create cynical and dispirited employees, alienate customers, and undermine managerial credibility.” Lencioni, P.M. (2002)

5.3 Strategic Objectives

Strategic objectives need to be developed from the vision, mission and values of the organization. These need to be a few significant items which are clearly stated, relatable to all levels and challenging, but not impossible. In order to be number one or number two in every market GE recognised the need to drive extraordinary levels of improvement in quality, cost and timeliness of delivery to customers. This is where Six Sigma came in.

5.3.1 Strategic Planning and Execution

The vision, mission and values of the organization need to be enacted through an effective planning and execution cycle. This is the only way in which the slightly intangible concepts and promises can be made manifest. The primary role of strategic planning is to set the right objectives for the business, determine the best means of achieving the objectives and to facilitate the effective implementation and review of the means as the plan is executed. This requires that planners should work in the context of higher-order purposes of the organization, which are usually very specific to its own situation including the needs and desires of the owners and stakeholders.



Empowering People. Improving Business.

BI Norwegian Business School is one of Europe’s largest business schools welcoming more than 20,000 students. Our programmes provide a stimulating and multi-cultural learning environment with an international outlook ultimately providing students with professional skills to meet the increasing needs of businesses.

BI offers four different two-year, full-time Master of Science (MSc) programmes that are taught entirely in English and have been designed to provide professional skills to meet the increasing need of businesses. The MSc programmes provide a stimulating and multi-cultural learning environment to give you the best platform to launch into your career.

- MSc in Business
- MSc in Financial Economics
- MSc in Strategic Marketing Management
- MSc in Leadership and Organisational Psychology

BI NORWEGIAN BUSINESS SCHOOL

EFMD
EQUIS
ACCREDITED

www.bi.edu/master

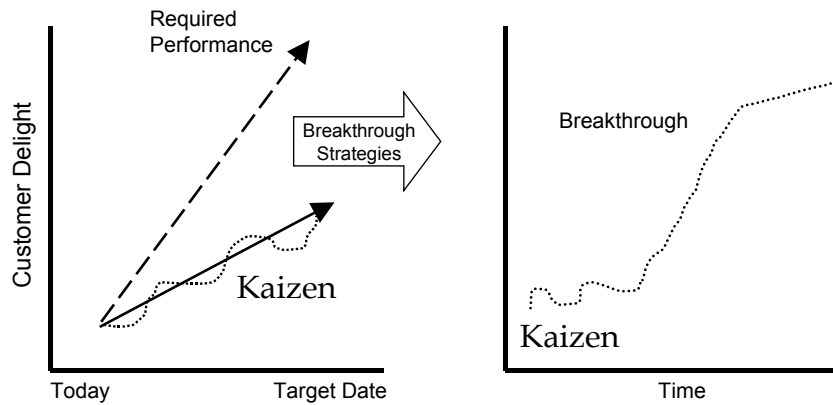

Figure 5.1. Breakthrough Performance

An example of a higher order purpose may be to provide the best products and services to society, with specific objectives of introducing four new products next year. Strategic management is needed in addition to strategic planning in order to translate the strategic intent through a reliable execution methodology into planned results. The planned results can be in the form of incremental or breakthrough improvements.

A plan to achieve the strategic vision must take account of both sets of activities. Incremental non-breakthrough activities improve current business processes through use of facts and analysis to solve recurring problems. These activities are often associated with the concepts and tools of total quality management. But some performance gaps are large and cannot be addressed by merely using an incremental approach to improvement because of the greater degree of change involved, as shown in Figure 5.1.

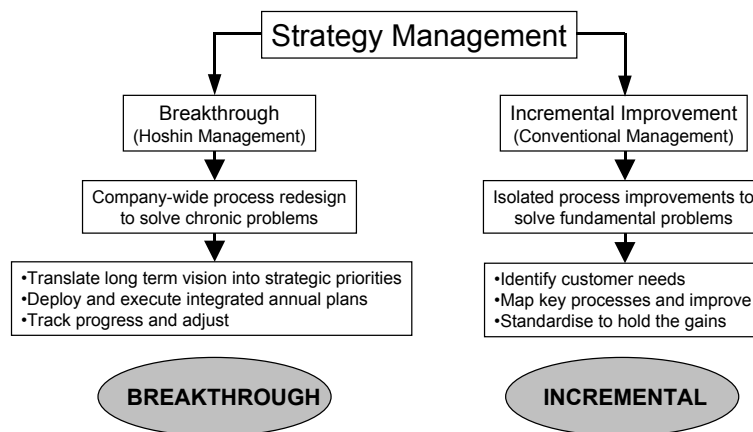

Figure 5.2. Breakthrough and incremental improvement

Incremental improvement (sometimes referred to as Kaizen) relates to isolated process improvements to solve fundamental problems. Breakthrough improvement often requires a company-wide process redesign to solve chronic problems. Six Sigma projects can be conceived to act at either level, as long as there is clarity on goals and timescales.

As has been mentioned earlier, linkages between Six Sigma projects and business strategy are vital for long term success. The model in figure 5.2 shows how this can be managed. Traditional approaches might include Management by Objectives (Drucker, 1954), but the one way nature of this approach has often been a problem in generating real buy-in to objectives throughout the organization. Recently, it has been suggested that Hoshin Kanri might be an effective approach to combine with Six Sigma to generate effective deployment, good strategic linkages and organizational alignment and buy-in (e.g. Yang and Yeh, 2007).

5.3 Hoshin Kanri and Six Sigma

The Japanese translation of Hoshin Kanri is as follows:-

“ho” – method **“shin”** - shiny metal showing direction **“kanri”** - planning

A useful interpretation of the literal translation is that Hoshin Kanri is a *“methodology for setting strategic direction”*, which is also known as Hoshin planning, policy management and policy deployment.

Hoshin Kanri is a planning system developed in Japan in the 1960’s as a derivative of Management by Objectives (MbO), and is believed to be dramatically superior to other forms of planning, particularly for integrating Total Quality Management (TQM) with the business plan of an organization.

5.3.2 Hoshin Kanri Planning Principles

Hoshin planning is not a strategic planning tool in itself, but can be thought of as an execution tool for deploying an existing strategic plan throughout the organization, although it can facilitate the strategic planning process. It does depend on having a clear set of objectives articulated by the Chief Executive/Company President. Application of Hoshin Kanri will then translate the strategic intent into required day-to-day actions and behaviours.

Hoshin planning principles are formulated around companies knowing what their customers will want in five to ten years, and understanding what needs to be done to meet and exceed all expectations. This requires a planning system that has integrated Deming’s *“Plan-Do-Study-Act”* language, and activity based on clear long-term thinking. The measurement system needs to be realistic, with a focus on process and results and identification of what’s important. Groups should be aligned with decisions taken by people who have the necessary information. Planning should be integrated with daily activity underpinned by good vertical and cross-functional communication. Finally, everyone in the organization should be involved with planning at local levels, to ensure a significant buy-in to the overall process. Figure 5.3 shows a model of the Hoshin planning system.



Figure 5.3. The Hoshin Planning System (Tennant and Roberts, 2001)

Need help with your dissertation?

Get in-depth feedback & advice from experts in your topic area. Find out what you can do to improve the quality of your dissertation!

Get Help Now



Go to www.helpmyassignment.co.uk for more info



The major elements of the model can be summarised as:

- **Five-year vision:** This should include a draft plan by the president and executive group. This is normally an improvement plan based on internal and external obstacles, and revision based on input from all managers on the draft plan. This enables top management to develop a revised vision that they know will produce the desired action.
- **The one-year plan:** This involves the selection of activities based on feasibility and likelihood of achieving desired results. Ideas are generated from the five-year vision, the environment and ideas based on last year's performance. The tentative plans are rated against a selection of criteria and a decision made on the best action plans.
- **Deployment to departments:** This includes the selection of optimum targets and means. It focuses on the identification of key implementation items and a consideration of how they can systematically accomplish the plan. The individual plans developed are evaluated using the criteria that were used for the one-year plans.
- **Detailed implementation:** This is the implementation of the deployment plans. The major focus is on contingency planning. The steps to accomplish the tasks are identified and arranged in order. Things that could go wrong at each stage are listed and appropriate countermeasures selected. The aim here is to achieve a level of self-diagnosis, self-correction and visual presentation of action.
- **Monthly diagnosis:** This is the analysis of things that helped or hindered progress and the activities to benefit from this learning. It focuses attention on the process rather than the target and the root cause rather than the symptoms. Management problems are identified and corrective actions are systematically developed and implemented.
- **President's annual diagnosis:** This is the review of progress to develop activities which will continue to help each manager function at their full potential. The president's audit focuses on numerical targets, but the major focus is on the process that underlies the results. The job of the president is to make sure that management in each sector of the organization is capable. The annual audit provides that information in summary and in detail.

5.3.3 Phases of Hoshin Planning

In order to apply the principles of Hoshin planning effectively, there are a number of prerequisites that an organization have in place. It is not sufficient to attempt to translate to an environment of Hoshin planning as a short term solution.

Instead the organization must develop a strategy based on the five phases as suggested in Figure 5.4.

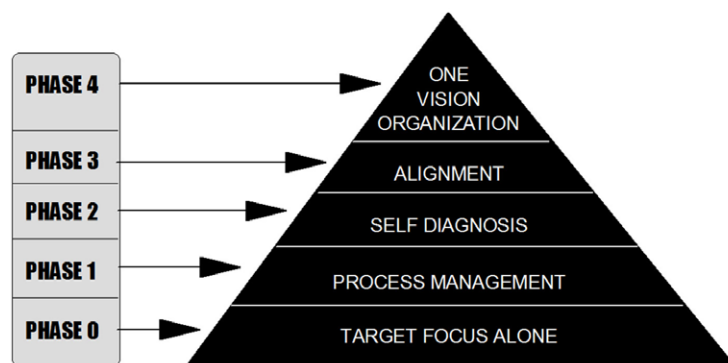

Figure 5.4. Phases of Hoshin Planning

5.3.4 Cross Functional Management and “Catchball”

Cross-functional management (CFM) is necessary for successful implementation of Hoshin Kanri along with a concept known as “*catchball*”. CFM requires a significant change in the structure of management relationships, in order to allow continual checking of goals and means throughout the implementation cycle to steer the organization to its new direction. Catchball is a term derived from the children’s ball game, where instead of a ball, an idea or goal is tossed around from person to person. It is a vital element which requires constant communication, to ensure the development of appropriate targets and means, and to their deployment at all levels in the organization. Systems must be implemented to ensure feedback in bottom-up, top-down, horizontal and multi-directional horizons. To realise such a communication network, there must be a company commitment to employee involvement and continuous improvement. This approach builds buy-in through participation in the goal-setting process, and consensus with the team to ensure appropriate levels for goals and targets.

The positive aspects of Hoshin planning rather than management by objectives are the specific focus on measuring results through process rather than targets. In management by objectives the objectives of the target setting and measurement tends to be on business tangibles such as profits and cost. The organization tends to engender a culture of individual orientated management control and trouble shooting, rather than teamwork and continuous improvement. Hoshin planning tends to focus on self-assessment with individual participation and flexibility. Therefore the focus is on individuals making plans that are tied into a company vision, diagnosis of company processes and comparing actual results against the original targets.

5.3.5 The Benefits of Hoshin Kanri/Six Sigma Combination

The benefits of Hoshin Kanri as a tool for Six Sigma compared with conventional planning systems include; integration of strategic objectives with tactical daily management and improvement projects; the application of the plan-do-check-act circle to business process management; parallel planning and execution methodology; companywide approach and integration of projects into wider plans; improvements in communication; increased consensus and buy-in to goal setting and project definition; cross-functional-management integration. Taken together, these reduce the propensity for opportunistic application of Six Sigma projects for short-term financial gain, and bend them to the strategic purpose of the organization. The transparency of the approach and the catchball system should also have the effect of reducing resistance at both the initiative and project level as Six Sigma becomes a tool to help areas address their goals rather than an initiative imposed from outside.

5.4 Summary

Returning to the model from chapter 4, we can see that Hoshin Kanri provides an effective interface between the strategic and tactical (project) cycles of the model, an area which has been left vague in most of the Six Sigma literature.

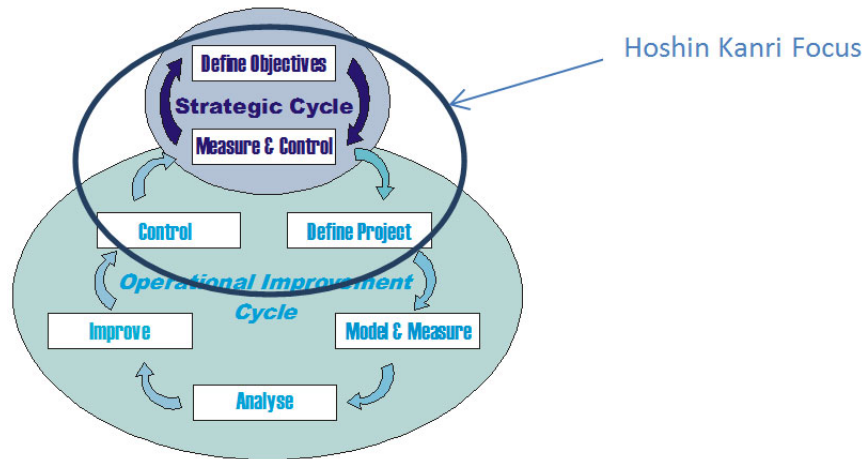

Figure 5.5. The Supply Chain Conceptual Improve

Review & Discussion Questions:

1. What are the potential benefits of the catchball process to Six Sigma implementation?
2. What are the core values of a Six Sigma organization?
3. How might these best be communicated?

Brain power

By 2020, wind could provide one-tenth of our planet's electricity needs. Already today, SKF's innovative know-how is crucial to running a large proportion of the world's wind turbines.

Up to 25 % of the generating costs relate to maintenance. These can be reduced dramatically thanks to our systems for on-line condition monitoring and automatic lubrication. We help make it more economical to create cleaner, cheaper energy out of thin air.

By sharing our experience, expertise, and creativity, industries can boost performance beyond expectations. Therefore we need the best employees who can meet this challenge!

The Power of Knowledge Engineering

Plug into The Power of Knowledge Engineering.
Visit us at www.skf.com/knowledge



6 Customers

6.1 Introduction

The jargon of ‘customer satisfaction’ is now very prevalent in most organizations, which is clearly a good thing. However, there is significant evidence that the practice of customer focus lags behind the rhetoric. Six Sigma is no exception in this regard, with the customer focus trumpeted in many texts being often superseded by cost considerations.

6.2 Customer Satisfaction and Customer Value

6.2.1 Customer Satisfaction

Customer satisfaction is a cherished notion, but it is rather reductive in its conception. Goetsch and Davis (2010) point out that if Customer value (as per the theory of service relativity) conforms to the equation below, when the results equal the expectation, and then the customer value is zero.

$$\text{RESULTS} - \text{EXPECTATIONS} = \text{VALUE}$$

This implies that satisfaction is the absolute minimum that should be expected, and that its achievement does little or nothing to enhance company performance in terms of retention of customers, or profitability. Exceeding expectations (and thus generating positive value) needs to be the goal.

Only when the customer sees value in our product will they actively choose it over others. Similarly, the concept of customer loyalty is not helpful. This is because customers are not loyal in any meaningful sense. They will stick with a brand as long as they perceive value there, but desert it as soon as they see more value elsewhere. This is most obvious in fashion-driven markets where this year’s hot designer is next year’s nobody, but is true of all markets. Our goal needs to be to create (and maintain) customer preference for our offering. The implication of this is that we need to constantly refresh that offering in the light of new market data, with the aim of staying ahead of the results minus expectation equation, given the fact that better results will automatically drive up future expectations.

6.2.2 Kano Model of Quality

The Kano model of quality (see Figure 6.1) indicates that the simplistic view of customers having requirements which improve satisfaction in a linear fashion depending upon the degree to which they are met does not fully reflect the complex nature of the process of satisfying customers.

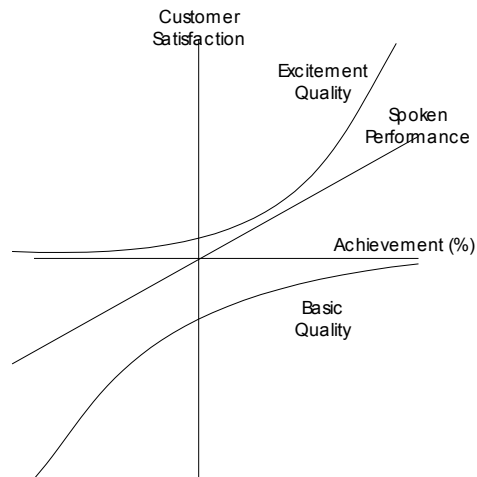

Figure 6.1. The Kano model of quality (Adapted from Kano, 1984)

Spoken performance issues will be of the form “I would like the product/service to achieve this level of performance”. If the performance meets or exceeds this level the customer will be satisfied on that issue. If it does not then the customer will be dissatisfied on this issue. There will be a roughly linear relationship between performance against the specified criteria and customer satisfaction in that area. However, this does not cover all eventualities. Basic quality is related to items that a customer will not specify performance levels for since he assumes these levels will be met as a matter of course. In effect, these are the assumptions that he/she makes about your product or service and if you achieve all these you will not greatly impress them. The big but, though is that if you fail to fully satisfy one of these criteria you will have a very dissatisfied customer on your hands. Excitement quality refers to giving the customer something he didn't know he wanted (witness the leap-frogging of each generation of smart phone with functions which most people couldn't have asked for but which they can now not do without). Clearly, no customer can be dissatisfied because you didn't give them something they didn't know they wanted but if you do then you have a chance of obtaining extraordinary customer satisfaction.

From the above we can see that, although spoken performance issues are important, the real areas where you may lose (basic quality) or win (excitement quality) large amounts of customers are in areas where the customer will not generally volunteer the requirements but where there is a need to get inside his/her head to understand in more detail how they view the product or service.

In marketing terms you might think of 'Basic Quality' as 'Order Qualifiers' – without them you are not even in the game. 'Spoken Performance' would be more like 'Order Winners', where you compete with the competition for best customer value. 'Excitement Quality' features are a competitive advantage; they are game-changers, such as the first smart phone, or the first electric window on a car. Your customers will think you know what they want before they do (Apple are arguably the most consistent users of 'Excitement Quality' features at present) and competitors will come under pressure to follow your lead. And the beauty is that, even if they create better versions of these features you are still in the customers mind as the innovators.

This has important implications for how we obtain the data as simple market research tends to focus more on spoken performance criteria.

6.2.3 Customer Value

Value is a complex measure which is shaped by a number of factors:

1. Freedom from faults.
2. Degree to which requirements/expectations are met.
3. Emotional engagement with the product/service.
4. Quality of contact with the supplier.
5. Cost of the product or service.



"I studied English for 16 years but...
...I finally learned to speak it in just six lessons"
Jane, Chinese architect

ENGLISH OUT THERE

Click to hear me talking before and after my unique course download



Freedom from faults speaks for itself, the product or service must be delivered to the customer as specified. Failure to do this reduces value as the customer will be dissatisfied. However, removing a cause of dissatisfaction only returns the customer to a neutral state; it does not actively satisfy them (notwithstanding the comment made above). If our response systems simply remove the causes of dissatisfaction we do nothing to address creating a positive experience for customers by addressing the degree to which customer needs and expectations (basic quality, spoken performance and excitement quality aspects) are met is significant to the value the customer will place upon the product. More complicated is the emotional engagement with the product or service; this is a combination of things such as: ergonomics, perceived social and cultural cachet, brand perception, aesthetics, linkage to self-image, etc. A product which looks beautiful (to the customer in question), fits their values (for example, eco-friendly), is seen as aspirational in the media and popular opinion, is easy (or ideally elegant) to use, and is associated with a brand which has high value for the customer will score highly on this element. Quality of contact with the supplier (whether web or direct) is also a major factor, customers often cite feeling important and cared for as a crucial factor in their decision to do business with a particular organization. Again, this is itself a complex issue with ease of interaction, perceived competence and degree of responsiveness of staff playing a part, among other things – this is dealt with in more detail in chapter 14 of “Managing Quality in the 21st Century” (also available from Bookboon). Finally, cost is important in assessing value; importantly, this does not just mean purchase price, customers are often sophisticated in assessing longer term costs (running, taxation and insurance costs for cars are a good example).

To add to the complexity the five factors interact in ways which are sometimes obvious, and sometimes not. For example, it is reasonably clear that if you buy a cheaper car, you may accept a few more faults, but how important is usability for a more aspirational product? For example, the Apple iPhone 4 saw no dip in popularity, despite issues with reception and signal strength when initially launched (PCWorld.com, 2010).

6.2.4 Six Sigma and Customers

Traditionally, Six Sigma projects engage strongly with points 1 and 5; 3 and 4 would often (perhaps correctly) be seen as out of scope; but many Six Sigma projects fail to make as effective a contribution to improving the degree to which customer requirements and expectations are met. To counter this, the strategic links to the value proposition for the organization need to be clear at the start of the project and value in assessing projects needs to be given to customer impact as well as to financial benefits. The difficulty of measuring this impact – especially in the short term – is an issue for an initiative where measuring is a key part of the mind-set, but this should not be an excuse for not trying.

6.3 Summary

It is important to understand the (complex) ways in which our products and services deliver value to the customer, and how we can manage the process of value creation in running Six Sigma projects. The benefits of this approach will show through in medium term results as customers who see more product value choose to purchase more and act as ambassadors for the product or service in question; and, perhaps more crucially in the long term, in the re-focusing of the organization on a customer-centric business model.

Review & Discussion Questions:

- 1. Consider a favourite product or service of yours. What is it you value, and what matters most? Can you develop clear requirements from this?*
- 2. Categorise your requirements revealed through the value you perceive into 'Basic Quality', 'Spoken Performance' and 'Excitement Quality' features.*
- 3. Taking your example from question 1 put yourself in the place of the supplier; how might you access customer requirements such as the ones you noted?*

7 Variation

7.1 Introduction

Figure 7.1 is the standard approach to achieving quality. This is the make-inspect approach which is still prevalent in much manufacturing (and indeed service industry as anyone who has seen Gordon Ramsey inspecting and disposing of the food on 'Hell's Kitchen' will understand).

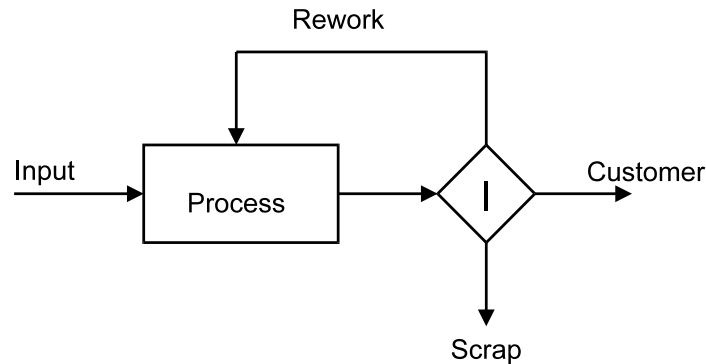

Figure 7.1. A process using 100% inspection.

What do you want to do?

No matter what you want out of your future career, an employer with a broad range of operations in a load of countries will always be the ticket. Working within the Volvo Group means more than 100,000 friends and colleagues in more than 185 countries all over the world. We offer graduates great career opportunities – check out the Career section at our web site www.volvogroup.com. We look forward to getting to know you!

VOLVO
AB Volvo (publ)
www.volvogroup.com

VOLVO TRUCKS | RENAULT TRUCKS | MACK TRUCKS | VOLVO BUSES | VOLVO CONSTRUCTION EQUIPMENT | VOLVO PENTA | VOLVO AERO | VOLVO IT
VOLVO FINANCIAL SERVICES | VOLVO 3P | VOLVO POWERTRAIN | VOLVO PARTS | VOLVO TECHNOLOGY | VOLVO LOGISTICS | BUSINESS AREA ASIA



There are four major problems that can be identified with such a system:

- ***It doesn't work***: 100% inspection is not 100% effective. No matter how good the inspector, some good products will always be rejected or sent for rework due to fatigue, boredom or a dozen other factors. More significantly, bad product will get shipped to customers.
- ***It is expensive***: The system is costly in terms of manpower; enough inspectors must be employed to ensure that inspection does not become a bottleneck in the production system.
- ***It is too late***: Products have already been made before diagnosis, and often there is sufficient lag between production and inspection that any feedback would be meaningless.
- ***It misplaces responsibility***: Responsibility for quality devolves from the person making the item to the inspector of the item whilst the control of quality remains where it always will remain, with the person in control of the production process. Thus, the only one with the ability to affect the final quality of the finished product has no incentive to pursue such improvements.

The logical way to overcome the problems associated with this type of system is to apply preventative techniques at the operation stage to ensure that the product is produced to the required quality. This means that we need to understand the variation in a process and manage it on that basis. The long-term aim is to minimise variation in processes so that customer requirements are more closely met than before.

7.1 Special and Common Cause Variation

Variation is part of our everyday lives. Both at work and in our private lives we make allowances for its effects from the process of getting to work in the morning to the output of a complex manufacturing system. However, whilst a seat-of-the-pants approach to deciding how long we allow ourselves to get to work may be perfectly adequate, a similarly haphazard approach to managing processes at work is not desirable. We need to get a **quantitative** feel for the variation in our processes. There are two basic elements to this variation: the central tendency and the spread. We need to have a handle on both these since they are vital to a successful process. It's no good being the right temperature on average if, to achieve this, you've got one foot in the fire and one in the fridge!

At this stage it is important to note the two potential causes of variation that can affect a process, these will be illustrated by means of a simple example of driving to work in the morning: even when we set off at exactly the same time, following the same route, in the same car it is apparent that arrival time will vary.

Common Cause (Unassignable) Variation: This is variation that is inherent in the process; it is always there. In the process of getting to work this will mean things like waiting time at fixed traffic lights, or the driver's mood and condition, or weather conditions. Only fundamental action on the process can change common causes. For example, changing route to avoid the traffic lights will remove that cause of variation.

Special Cause (Assignable) variation: This is variation due to transient causes outside the process norms and can usually be traced back to the specific cause. In the journey to work example this would include road works, breakdowns etc. In many cases action can be taken to achieve a reduction in the future effect of these 'transient problems'. For example, better maintenance to avoid breakdowns, which does not fundamentally change the process.

The difference between the two types of variation is crucially in their effect on the process. Common cause variation affects the overall spread of the process (so, for example, a journey with a lot of traffic lights would tend to have a wide variation as the variation caused by red or green at each light would add up), it would not affect predictability. A process which is subject to only common causes will be predictable (within limits), so we know that our journey to work might take between 20 and 30 minutes provided that nothing odd happens. We cannot, of course, predict the exact time it will take tomorrow, but we can make sensible decisions with regards to process management.

On the other hand, a special cause will tend to not only increase variation but also to destroy predictability. For example, if you were involved in a road traffic accident you would expect the journey to take longer. It would not, however, be possible to estimate the effect; it might be 10 minutes to exchange insurance details with anyone else involved, or if the car was no longer fit to drive you might miss the whole day at work. If a process is unpredictable it is not possible to make any sensible management decisions; you could not, for example, allow an extra 30 minutes for your journey time if you knew you were going to have an accident.

Accordingly, a process which is subject only to common cause variation is described as being ***“In Statistical Control”***. This is sometimes reduced to ***“In Control”*** or described as ***“Stable”***. This essentially means it is predictable, and we know what is coming (within limits). When a process is under the influence of special causes it is described as being ***“Out of Statistical Control”***, ***“Out of Control”*** or ***“Unstable”***.

To effectively manage a process we need to be able to distinguish between In Control and Out of Control conditions. A process which is not predictable allows us to make no assumptions about output and we must therefore inspect every item to ensure it is acceptable for the customer (Ramsey in Hell’s Kitchen). If a process is in control then we can plan because we know what is coming. Unpredictability – and hence special cause variation – is the enemy of process management.

7.2 Process Capability

Once a process is stable, it is necessary to determine whether the outcomes of the process can meet customer expectations – as described by tolerance limits in most product oriented applications and service level agreements in service oriented applications.

The importance of understanding process capability cannot be overstated. If we are to attempt at any level to design for manufacture we need to understand not only the requirements on the process (effectively our specifications) but also what the process is able to achieve (capability). Without both sides of the equation we are not able to make sensible decisions about how to manage our processes at an appropriate stage in the product lifecycle and we doom ourselves to fixing and fire-fighting when we actually try to make the product. A similar argument could be made for supplier selection.

Capability evaluation is the method by which we determine whether a process is up to the job of meeting the specifications set for it. It is important, before attempting to establish the capability of a process to ensure that the process is stable. The key issue is that if a process is not stable the capability will be constantly changing due to the transient effects of special causes and will hence be uncertain.

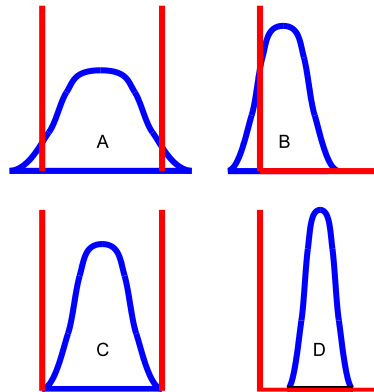

Figure 7.2. Process capability diagrams

Consider the four processes shown above with the specification limits. Clearly, process A is producing many components both above and below tolerance; process B is offset and is, as a result, producing components below the bottom tolerance limit; process C is producing almost all components within tolerance and process D is operating well within the tolerance limits.

The advertisement features a background image of a person in a red shirt running on a path during a sunrise or sunset. The Gaiteye logo is in the top left, with the tagline "Challenge the way we run". The main text reads "EXPERIENCE THE POWER OF FULL ENGAGEMENT...". Below this, a dotted line separates the text "RUN FASTER. RUN LONGER.. RUN EASIER...". In the bottom right, a yellow button says "READ MORE & PRE-ORDER TODAY" with the website "WWW.GAITEYE.COM" and a hand cursor icon.

Given the information provided in the above diagram we can act upon the process (resetting process B, for example, or attempting to reduce the spread of process A), without such information we would be making such decisions in the dark. Similarly, this information would be of use in selecting suppliers having these capabilities. If we do not understand the capabilities of processes at an early stage in the product lifecycle we give ourselves little chance of making appropriate decisions about which processes to use as they are and which to work on. If we find this out when we reach volume production we incur additional costs. Indices may be calculated to quantify capability, but these are not dealt with here.

The Taguchi Loss Function (section 3.4.1) demonstrates the tangible business impact of lower process capability (i.e. higher process variation).

The detail on both process control and process capability are dealt with in chapter 14.

7.3 Summary

Variation has a very significant impact on how effective an organization is in meeting customer requirements. The requirements can be in terms of physical dimension or performance of a product (miles per gallon in a car, for example) or time to complete a task or deliver a service (pizza delivery perhaps, or setting up a new bank account for a customer). A strategic recognition that this is the case, and therefore that variation is a key driver of both cost and customer satisfaction can lead to radical rethinks in business policies and support Six Sigma's drive for 'on target with minimum variation' performance.

Review & Discussion Questions:

- 1. Why is it important that a process is in control before process capability is calculated?*
- 2. What are the management implications of an incapable process? What about an out of control process?*
- 3. Many organizations have multiple suppliers of a single part to ensure that they are not too dependent on one supplier. What are the possible implications of this for process capability on the supplied part? How might this adversely affect the organization?*

8 Processes and Scientific Investigation

8.1 Introduction

8.1.1 Definition of a Process

A business process, simply defined, is any activity, or set of activities designed to change one or more inputs – which may be physical or information- into one or more outputs. It is desirable, although not universally true, that a process should in some way add value to the inputs so that the output is worth more than the combined value of the inputs and the processing. Figure 8.1 shows this in diagrammatic form.

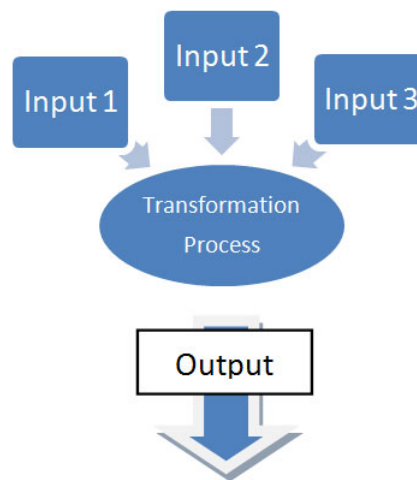

Figure 8.1. A process

Based on this definition, a process can refer to a physical manufacturing process or to a virtual or service operation where the output is not a physical product – a doctor’s advice, or the transfer of funds between bank accounts for example.

8.1.2 Production as a System

Deming’s (1990) model shows business as a process(figure 8.2).

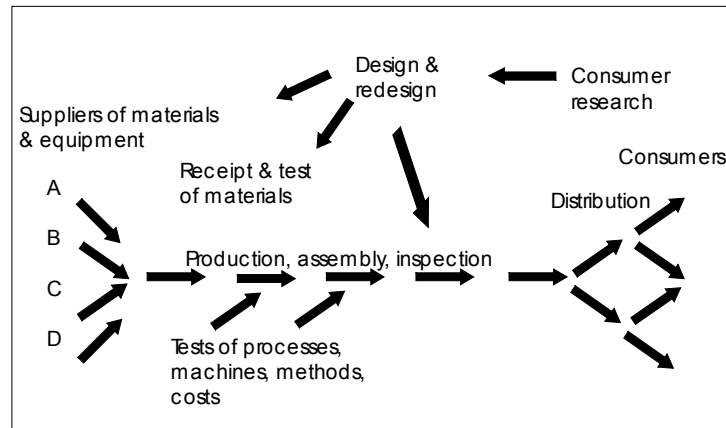

Figure 8.2. Production as a system (Deming, 1990)

The model looks initially chaotic, but simply reflects the myriad of activities that go on within a production environment. The flow is as follows:

- Consumer research drives an initial design.
- This is flowed down to suppliers who pass material into the organisation.
- The material is verified to design and passed into production.
- Processes, machines, methods etc. are monitored as the material flows through the production process.
- On successful completion goods flow into the distribution chain to consumers, whose feedback is sought to drive design changes as appropriate, and the cycle begins again.



This concept is hardly revolutionary now and, indeed, the wording of the model may look rather dated. However, the recognition that outputs of a process are clearly driven by inputs was the vital first step on the road to managing processes rather than outcomes. It may also be worthy of note that, even today, many management approaches spend more time focusing on the outcome than the means to achieve them (MBO and performance appraisal are perhaps chief amongst these).

Deming made some supplementary points on viewing production as a system. He noted that ‘the system must have an aim’ (defined by the customer of the process). An obvious comment, but it is amazing how often we lose sight of the end goal of the process in the endless debates over precedent and practicality which attend most manufacturing processes. Deming also noted that in the increasingly competitive production environment of recent years it is necessary to improve the system ‘constantly and forever’.

Perhaps the most insightful of his comments is that:

“Every organisation is perfectly designed to achieve the results that they do” (Deming, 1990)

This encapsulates the fact that processes drive results, and that if you wish to change the results you need to change the processes. Process design and management are thus seen as key to performing on all business measures. This demands a purposeful and planned approach to defining and refining the system with which we attempt to achieve our aims.

8.2 Business Processes: The Reality

Although Deming’s model is intuitively logical it can be seen that in many organisations the reality is that there exist ‘functional silos’ within the process. This is due to different departments or groups of experts ‘owning’ parts of the process and often having measures which conflict with each other.

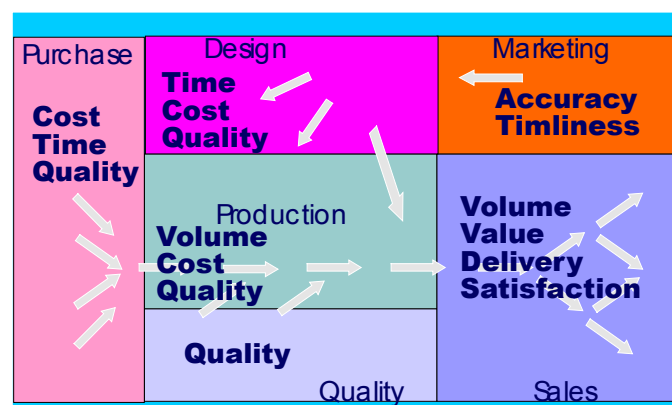

Figure 8.3. The Reality of Responsibility & Measurement in a Process (Adapted from Deming 1990)

Figure 8.3 shows schematically how this might look. The typical 'owner' departments are shown in each coloured segment and indications of key measurements that might be applied are shown in bold. It is interesting to note that the interfaces on this diagram require careful management if conflict is to be avoided. This, in effect, is where the continuous process model is most likely to break down with sub-process optimisation and local goals taking precedence over the broader picture. This picture is why the cry "I can't believe they work for the same company as me!" is so common, everyone is being driven by different goals so that the commonality of purpose one might reasonably expect breaks down.

Until departments can look beyond their own boundaries conflict will always exist. It can be argued that this integrating function is, perhaps the key function of management. Developing the vision and buy-in required to make this a reality can be supported by the application of Hoshin Kanri planning systems (see Chapter 5) and Six Sigma projects which focus on horizontal processes rather than vertical functional silos (figure 8.4).

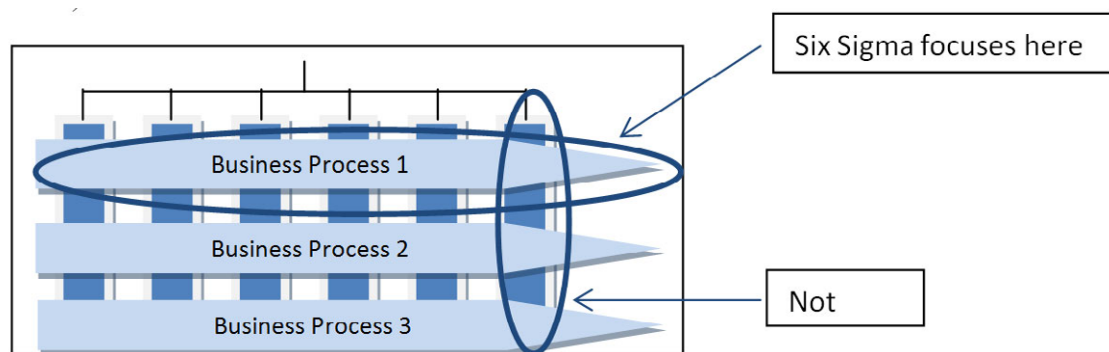

Figure 8.4. Business process versus functional organization focus for Six Sigma projects

In process terms it is important to understand the linkages between the purpose of the process (effectively customer requirements) and the key elements of the process which deliver the purpose. In Six Sigma terms we talk of the Critical Y's and Critical X's.

8.3 Scientific Investigation

The focus on the DMAIC cycle allows for a clear plan-do-study-act mentality and the use of evidence as a basis for Six sigma projects. The data-oriented mentality has to permeate the higher levels of the organization as well. Managers can no longer manage by 'gut feel' or 'experience' but must provide persuasive arguments based on the evidence for the actions they wish to take.

8.3.1 Transformation Process

Just as, at the project level, it is necessary to follow a structured process, this is also true at the initiative level. We can see how the three question model (figure 4.2 in Chapter 4) applies here, we need to know where we are going and how we will know when we get there. We then need to apply a Plan-Do-Study-Act logic to developing, implementing and monitoring an action plan to get us where we want to go.

8.4 Summary

Leadership must give up optimising departmental performance and focus instead on process performance. Results are only delivered through effective management of processes. If Six Sigma is used to optimise intra-departmental processes there is a significant risk that the overall process will be sub-optimised. This is the reason that many Six Sigma organizations find that when projects declare business impact figures the total systemic impact is much less than the sum of the declared project impacts. Projects must be based on the scientific method and value evidence above emotion in delivering improvement.

Review & Discussion Questions:

1. *Take an organization with which you are familiar. Draw a systems diagram to show how that organization delivers value to its customers.*
2. *Think about the departmental structure and write down the likely impact on the business and its customers if the departments pursue their own agendas instead of optimising the process as a whole.*
3. *How might you ensure unity of purpose?*

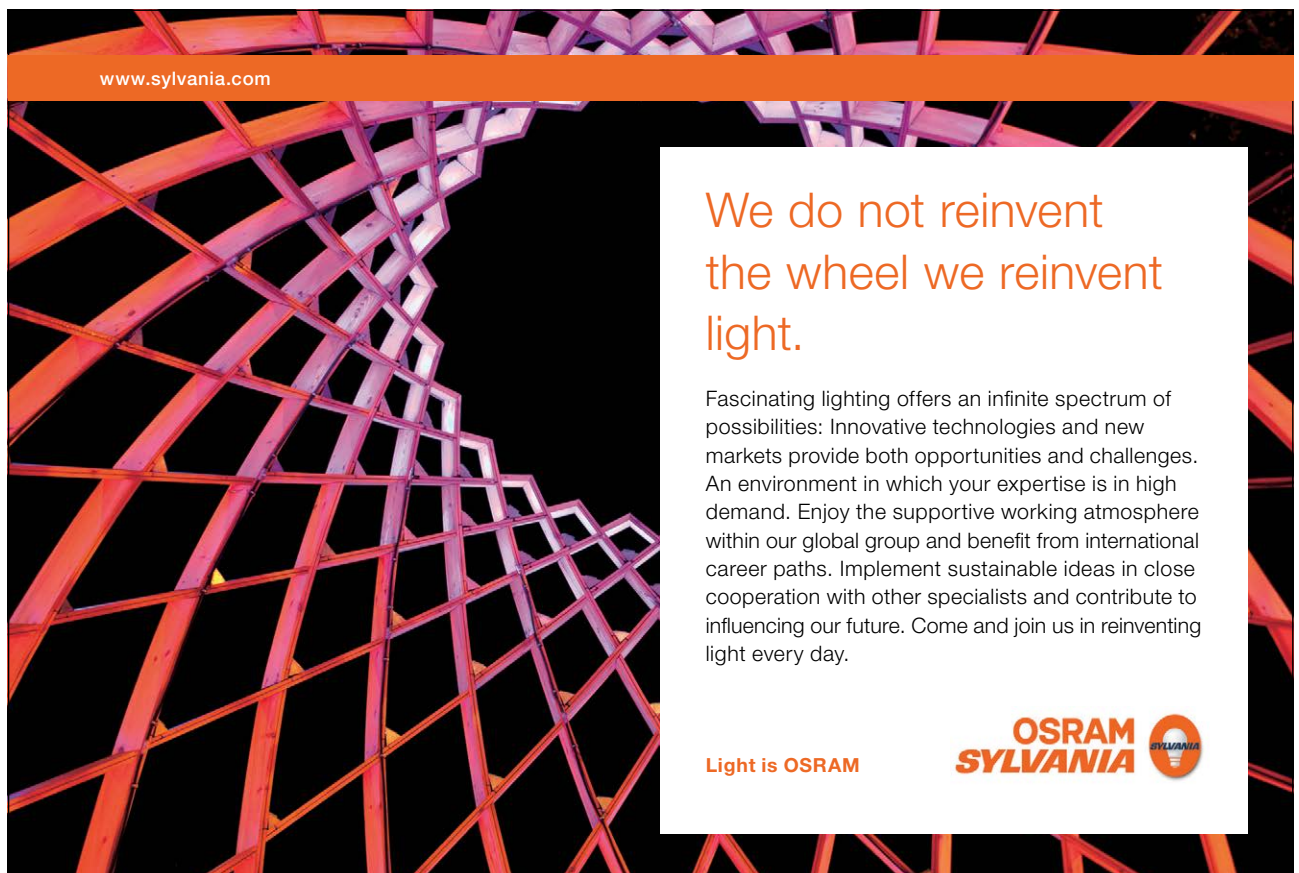

www.sylvania.com

We do not reinvent
the wheel we reinvent
light.

Fascinating lighting offers an infinite spectrum of possibilities: Innovative technologies and new markets provide both opportunities and challenges. An environment in which your expertise is in high demand. Enjoy the supportive working atmosphere within our global group and benefit from international career paths. Implement sustainable ideas in close cooperation with other specialists and contribute to influencing our future. Come and join us in reinventing light every day.

Light is OSRAM

**OSRAM
SYLVANIA** 



9 People and Organizational Learning

Eckes (2001) says that in his experience of Six Sigma deployments, the companies which did the best job of changing how they selected and developed their people had the best results. It is also recognised as probably the most variable aspect of Six Sigma implementation (Fleming et al , 2005; Jones et al, 2010).

9.1 Key Six Sigma Roles

One of the 'Six Triumphs' of Six Sigma cited by Goh (2010) is the clear assignment of roles and responsibilities within the initiative. Although the mantra of 'quality is everyone's responsibility' is correct in principle, the Six Sigma approach adds some focus in assigning specific roles to certain job titles.

9.1.1 Steering Team

Generally chaired by CEO and containing members (ideally all) of the senior team. As the team responsible for the strategic cycle they need to:

- Lead the Six Sigma transformation by generating vision and mission and linking this to the programme in a visible manner.
- Monitor and motivate the progress of projects.
- Have an integrated view of the projects and their links to strategic objectives.
- Co-ordinate cross-functional activities such as training.

9.1.2 Champion

This role is a non-executive role within the project team; the champion is a senior manager who supports the project and provides a bridge to the steering team (and hence the strategic cycle).

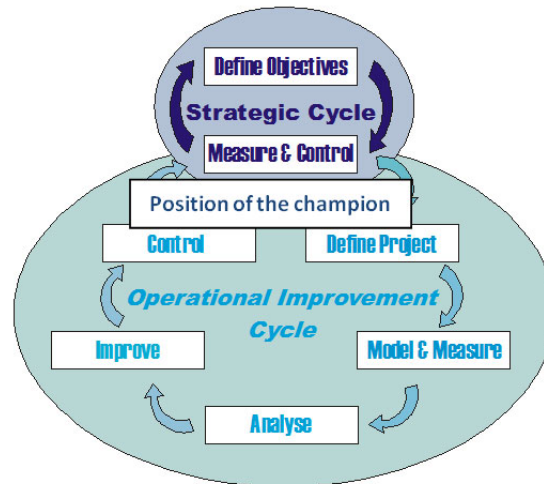

Figure 9.1. Champion links the strategic and tactical cycles (Adapted from Knowles et al, 2005)

The most important role of the champion is to address barriers that are beyond the team's authority or scope. This is important to ensure teams feel supported and do not lose momentum. They will also be held responsible for this aspect of the project as well as the effective operation of the team (although not the outcomes).

9.1.3 Master Black Belt

As experienced and successful Black Belts the role of the Master Black Belt is to provide subject leadership and project mentoring to the Black Belts and Green Belts running projects. They also liaise with Champions to provide effective support.

9.1.4 Black Belt/Green Belt

Lead the project team in improving the process. Responsible for delivery of the project outcomes and for facilitating the team through the application of the DMAIC process. According to Keller (2001) the characteristics of a successful Black Belt include:

- **Positive Thinkers:** Upbeat and optimistic about programme success. Self-confident without being overbearing or defensive.
- **Risk Takers:** Comfortable as change agents, happy to be leading, pleased to be at the leading edge of change.
- **Good Communicators:** As the technical hub of the team they need to communicate details of tools to less well trained individuals. More importantly change is difficult for both team members and the Black Belt will need to listen to concerns and respond positively to ensure buy-in to the project methods and outcomes.
- **Respected by Peers:** Credibility is key.
- **Leaders:** They are central players in the improvement and need to accept the leadership role.

9.2 Belt System Issues

Goh (2010) comments on the 'obsession with personal attainment' associated with the Six Sigma belt system. Too many practitioners, he feels focus on this as an end in itself. There are also issues around reward systems which sometimes give bonuses to Black Belts based on savings made. This may encourage game playing and over-claiming of benefits.

The second issue with the 'Belt' system is that by creating a parallel structure in the organization responsible for (and often rewarded based on) improvement activities the rest of the organization is largely isolated from Six Sigma, except as occasional secondees on projects or as 'victims' of experts parachuted into their area. This may cause resentment in the wider organizational context. Further than that, it can lead to improvement being seen as the preserve of the Six Sigma elite and discourage others from making (perhaps simpler, lower level) improvements to their processes as they are not experts.

9.3 People and Change

9.3.1 Emotional Aspects of Change

Six Sigma is about change, at all levels. The textbooks on Six Sigma focus very much on the process of change but, as McAdam and Lafferty (2004) note, Six Sigma requires attention to both methodology and behaviours (people). This is, in large part, conspicuous by its absence in both practical and scholarly literature (Moosa and Sajid, 2010). Where change is considered as a topic at all it is usually considered in a mechanistic, process focused context with resistance being seen as a problem. The most common title of chapters in this respect is 'Overcoming Resistance' which clearly casts resistance (and resisters) as a 'problem' to be solved. Logic and clear communication is often seen as the way to address the 'irrational and emotional' responses of the non-initiated.



360°
thinking.

Deloitte.

Discover the truth at www.deloitte.ca/careers

© Deloitte & Touche LLP and affiliated entities.



Much of being an effective manager of change comes down to understanding these ‘emotional’ reactions in others – where do they come from, what do they hope to achieve through it and most importantly, what can you do to help them move forward.

The starting point is to begin to develop a high degree of self-awareness – what is your motivation, why do you maintain the beliefs and values that you hold dear, what drives your behaviour and what effect does this have on others? Remember also that you are dealing with individuals – terms such as ‘the shop floor’, ‘the workers’, ‘the management’, ‘the front office’ and so on are generalisations that hide a multitude of attitudes, emotions, motivations and behaviours. They do not describe the individuals that work within these units.

Figure 9.2 is adapted from the grief curve defined by Kubler-Ross. This recognises that all change involves loss. In an organizational sense this can be loss of expertise, status, connections and contacts, or control. The initial response is to deny the need for change, followed by resistance (which can be active or passive), then engagement with the change and exploration of possible effects followed by commitment to the new status quo. However, it should be noted that this does not occur at the same rate for all and that adverse interactions can send an individual back to an earlier phase. As a leader of change it is important to understand that all those involved go through this process (even you!) and that your job is to help them (and you) work through the emotional side of the change as well as the practical one.

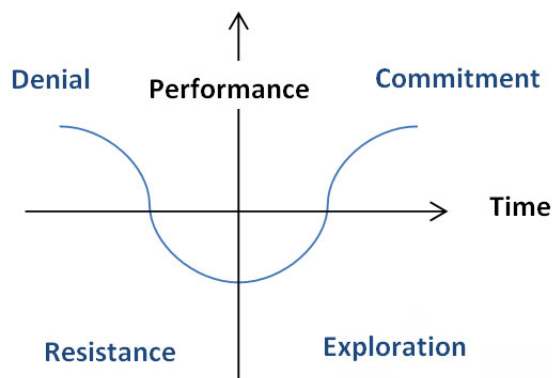

Figure 9.2. The emotional phases of change (adapted from Kets de Vries and Miller, 1984)

Focusing on the individuals in change is an essential element of success. However we are talking about organisational change so we need to also consider the effect of the organisation. In the literature on change you will find a good deal of discussion of the relative merits of top-down and bottom-up change. Naturally there are strong arguments for both. Top-down change provides a framework for the organisation through the use of Strategy, strong Vision and the provision of enablers for change – such as resources, money, time, external support and so on. The down side is that often the requirements for the change are not fully understood at a local level, the message is lost on the way and the individuals in the organisation can feel uninvolved and therefore are unlikely to be motivated towards effective implementation. This would fit the typical Six Sigma deployment, as we shall see later.

Bottom-up change ensures that the change is based on a good understanding of local conditions, the needs of a particular unit of the business and the skills and interests of the people within it. You may have heard the expression that the best way to get someone to support an idea is to get them to think that it is their own, well this is very true. A major benefit of a bottom-up approach is that through involvement you can gain understanding and commitment. The down side of bottom-up change is that it can result in sub-optimisation of processes if the scope of the project is not great enough and of course it can meet with opposition from above if it is not seen to be supporting the goals of the business – or the goals of the individuals who have the right of veto.

As with many aspects of change the answer is to do both. This approach has been described as ‘Need-down, How-up’. That is the strategy and direction are provided from above (top-down) whilst the solutions and approach to change is generated locally and fed back up the hierarchy (bottom-up). We have seen this approach work well in an organisational context with Directors providing the strategy and a multi-functional, multi-level project team providing the solutions – presented back to the Directors as “This is what we are planning to do and this is the support we need from you in order to achieve it”. You may want to look again at Hoshin Kanri in chapter 5 in this context.

Whether you are looking from the top down or the bottom up or even somewhere in the middle looking both ways it is important to recognise that successful change is achieved through the changing behaviour of individuals and groups within the organisation. This change in behaviour only follows if people are motivated towards it – they need the answer to the question “what is in it for me?” This motivation comes through creating meaning. The key to creating meaning is involvement – that is, when people are fully involved in creating change than they are given a real opportunity to develop their own understanding of what it means for them.

If you are not able to fully involve everybody in the change then you will have to rely on effective communication to spread understanding and meaning. There are many way to communicate information but the most important aspect is to remember that it is a two way process. The meaning of the communication is in the response it elicits and different people will need different approaches – don’t guess what makes people tick, build relationships based on trust and mutual understanding.

9.3.2 Participation

Quality improvement is a participative process. It is a very significant activity and it cannot be left to a small proportion of the organization to deliver its goals. Participation is all about involving a wide variety of employees in as much of the organizational strategy setting, policy making and deployment, and process improvement as possible. By mobilizing the brain power of all individuals within the organization it is possible to generate better ideas, better decisions, better productivity, and better quality (Goetsch and Davis, 2010). As we have already seen, the wider the participation, the more complete the organizational buy in to approaches and the more comprehensive decisions, process designs, etc. are likely to be.

9.3.3 Empowerment

If participation refers to the breadth of involvement within a company then we might want to think of empowerment as the depth of involvement. Empowerment is strongly linked to ownership. In empowering our employees we give them genuine ownership of the processes they run. True empowerment allows them to make decisions about how to do their jobs, how to best serve customers and what actions are in the best interests of the company. An empowered employee is able (and willing) to question the status quo in his part of the organization; asking not just 'how can this be done better?', but 'why are we doing this?' Empowerment implies trust; a manager must trust her staff before she can empower them, otherwise she will feel the need to put in checks and approval systems. Clearly in some cases these are necessary, but the central idea of empowerment is for decisions to be made as close to the process in question as possible. Semler (1993) points out that most participative leadership amounts to little more than consultation, as managers retain the decision making. Until you allow employees to take decisions they are not empowered and practical participation is hamstrung.

Empowerment may also require significant amounts of training; it effectively enlarges the job of the employee and they need to be prepared to take on the additional responsibilities. In some cases individuals and teams are fully able to adopt empowerment without any additional training, but where this is not the case it is unfair to push responsibility at an individual without giving them the tools to discharge the responsibility effectively. In Six Sigma the Master Black Belts, Black Belts and, to a lesser extent Green Belts are all reasonably empowered, the trick is to spread this throughout the organization. The long term goal is to have an organization where the principles and approach of Six Sigma have become second nature, reducing (possibly to zero) the need for the Belt structure. Toyota, for example, point out that one of the reasons they have not pursued Six Sigma is the implied elitism. Toyota want everyone involved in improvement, not just a few specialists (Bicheno and Holweg, 2008).

SIMPLY CLEVER





We will turn your CV into an opportunity of a lifetime

Do you like cars? Would you like to be a part of a successful brand?
We will appreciate and reward both your enthusiasm and talent.
Send us your CV. You will be surprised where it can take you.

Send us your CV on
www.employerforlife.com

To create an empowered workforce the role of management is to create the environment for empowerment to happen. This will involve things such as:

- Encouraging challenge and questioning; not being defensive of their position.
- Facilitate and mentor to help people take on extra responsibility.
- Acting quickly on concerns where possible, recognizing efforts and accomplishments.

9.4 Organizational Learning

Six Sigma is a learning friendly process according to Wiklund and Wiklund (2002), they point out that improvement without learning is impossible. An organizational learning cycle can be identified, which is similar to the PDSA cycle, which is the basis for DMAIC. Dixon (1994) described such a cycle.

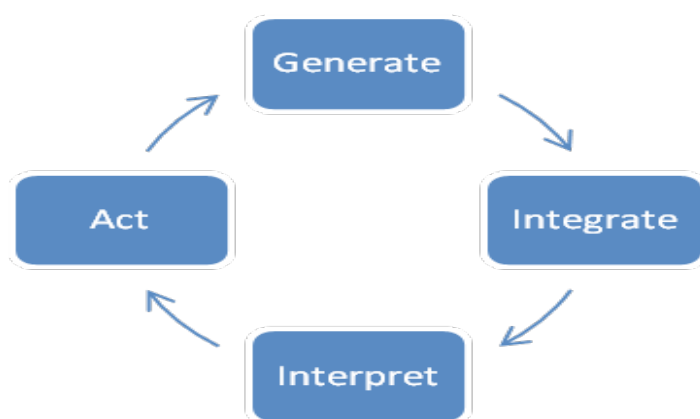

Figure 9.7. The Organizational Learning Cycle (Dixon, 1994)

- Experiences need to be spread throughout the organization in order to *generate* learning.
- Reflection, at this higher level, requires the *integration* of the experience into an organizational context.
- To create shared concepts and mental models collective *interpretation* of the contextualised experience takes place.
- *Action* is required to test the analysis, which underpins the interpretation.

Organizational learning can take place at a number of levels; it can apply to small teams (such as Six Sigma project teams), departments or the organization as a whole. This can account for the apparent inconsistencies in behaviour and ethos between departments in the same organization. The models and behaviours, which form the essence of the departmental culture, are the results of learning mechanisms that have taken place over time in those departments.

At the initiative level, the task is to create an environment which is conducive to learning, and which supports not only the learning cycle for individual projects, but also the development of wider organizational learning based upon the sharing of knowledge. There is more detail on creating a Learning Organization in “Managing Quality in the 21st Century” on Bookboon.com

9.5 Summary

The principles which need to influence the people aspects of the strategic implementation of Six Sigma are set out in this section. This softer side of Six Sigma is often neglected to a large degree in the way businesses introduce the approach, and in many texts. The belt roles provide a strong and clear assignment of roles and responsibilities for improvement which is a strength (Goh, 2010) but also risks alienating the rest of the 'non-belted' organization and hampering wider efforts at business improvement.

Review & Discussion Questions:

1. *Compare and contrast the Six Sigma focused improvement through experts approach with the Lean wider involvement approach. What are the strengths and weaknesses of each?*
2. *Can they be effectively combined?*
3. *If so, what would be key in making such a combination successful?*

10 Sustainable Six Sigma Deployment

This section builds upon the principles discussed in the previous sections to consider how to deploy Six Sigma in a sustainable fashion.

10.1 Deployment Model: Kotter

There are a large (and growing) number of deployment models and associated guidance available in the literature (e.g. Pande et al, 2000; Moosa and Sajid, 2010), and there will be an ISO standard for Six Sigma published soon. This text will not be following any of them, but will consider more generic approaches. Kotter's (1996) 8 step model is perhaps the most commonly used generic change model:

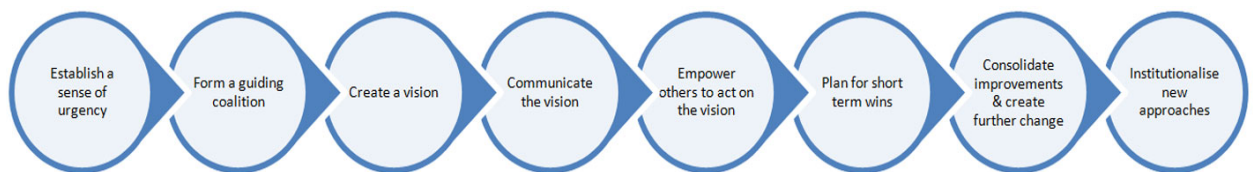

Figure 10.1. Kotter's change model (adapted from Kotter, 1996)

I joined MITAS because
I wanted **real responsibility**

The Graduate Programme
for Engineers and Geoscientists
www.discovermitas.com



Month 16
I was a construction supervisor in the North Sea advising and helping foremen solve problems

Real work
International opportunities
Three work placements





10.2 Deployment Logic: System of Profound Knowledge (SoPK)

The model provides the mechanism for change, but Deming's System of Profound Knowledge (Deming, 1990) shows the thinking which needs to go into each step.

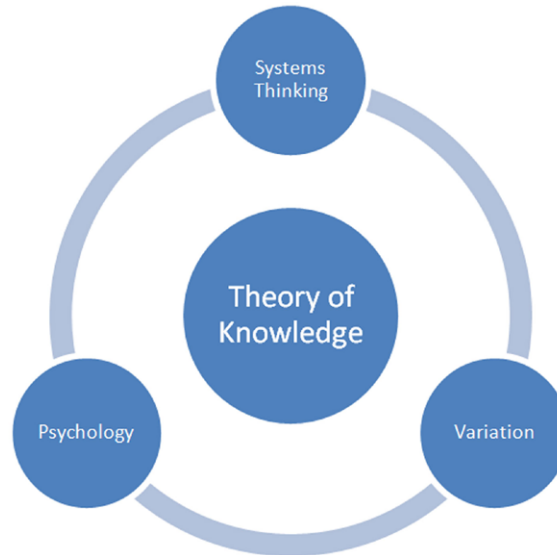

Figure 10.2. The System of Profound Knowledge (adapted from Deming, 1990)

The approach (an adapted model of which is shown in figure 10.2) combines systems thinking with an understanding of statistical analysis, a people focus and a learning approach based on the knowledge generated from the other elements.

Systems Thinking: This is the art of seeing the world in a joined up way. It involves seeing your organization as a system, rather than taking a reductive approach to considering only the individual parts. It is important that everyone in the system understand the system aims and understands the process through which outcomes are obtained. Changes need to consider consequential and indirect impacts.

Variation: All processes vary, but is the variation predictable? Is the variation acceptable to customers? Do people understand how to react appropriately to different kinds of variation?

Psychology: People are a very important part of the system. How will they react to changes? How do they feel about their work? Do variation or other parts of the system cause stress or lead to inappropriate behaviours? How will the decisions managers make impact on the people in terms of motivation, pride etc.? How open is it possible to be in the company environment?

Theory of Knowledge: Plan-Do-Study-Act is known as 'The Deming Cycle'. It is the scientific method in practice. We must seek to learn from our experiences, in particular considering the other 3 elements of the System of Profound Knowledge. We must seek to understand the effects of decisions and changes, look for evidence and judge only on this.

It is the integrative nature of the model that is most important to consider at this stage. Deming's point was that piecemeal consideration of these issues would be likely to lead to sub-optimal outcomes and an undue focus in one area.

10.3 Steps 1 to 3: Envisioning the Transformation

The first step in transforming an organization is the recognition that current approaches and levels of performance are not sustainable in the long term. The senior team needs to recognise that something can be done, and that something must be done. The need for change needs to be clear and communicated. The usual form that this takes in Six Sigma is a litany of current failings and comparisons to superior competitors in order to create dissatisfaction with the status quo. However, this may have a negative impact on the early phases of the emotional journey of change; we are all invested in our existing processes to some extent and beginning change by attacking them may harden the initial denial and resistance phases. Also, being told you are no good tends to sap the energy of an organization. An alternative might be to take an approach like Appreciative Inquiry (Whitney et al, 2010) which starts with the belief that what we are looking for already exists somewhere in our organization and the task is to discover what works well and understand how that can be grown and expanded in order to operate effectively across the organization. This aids buy-in by celebrating the good in the existing system and looking to grow it. This may create the desired state of unhappiness with the current position.

It is helpful if management do not arrogantly assume they know the ills of the organization; this can create a parent child relationship rather than create a coalition of the willing (to borrow a phrase rather discredited by recent history). A good place to start is by asking what is frustrating individuals in the organization, this again helps with buy-in and meaning for the individuals concerned and allows them to commit more easily to change as they can see what is in it for them. Gillett and Seddon (2009) suggest that a good way to start learning about current status is through some initial improvement projects. It also means that the senior management view of the problem is likely to be more complete and accurate, and thus the beginnings of the initiative more genuinely congruent with the issues.

Some are concerned that the bottom up element here might drive changes which are not in the strategic interests of the organization. This is to miss the point; firstly, if the strategy has been correctly deployed then it is very likely that the things which frustrate individuals at their organizational level are strongly related to their inability to do the job they wish for in the organization. Sarmiento, Beale and Knowles (2007) show that there is a positive and significant association between job satisfaction and performance. In short, what makes people unhappy is likely to be what is inhibiting performance. Also, the job of the top team is to make sense of the feedback and to create a strategic approach which effectively marries top down and bottom up issues.

This approach recognises a wider definition of the guiding coalition than is the norm. This is usually seen as being the 'top team' or a range of senior execs and managers. Clearly, these are important people who will drive the process, but if we build a coalition which ranges from the top to the bottom of the organization then we make their job much easier by giving them allies in every part of the business. Of course, it is naive to think that everyone will be engaged by this process, but it is about generating a critical mass, and this is much more likely achieved through engagement than through preaching.

Once the senior team has digested the feedback from around the organization it is time to develop a vision and mission which will motivate the whole organization to move towards the desired future state. The development/deployment approach (Hoshin Kanri) is covered in some detail in chapter 5 so will not be covered further here, except to make a few key points:

- **A Learning Approach to Strategy (Pedler et al, 1997):** The deployment of strategy is a learning process, the Hoshin catchball process is a key way of getting feedback on the sense and practicality of the strategy. As per the SoPK always look to learn at every step of the deployment. This is a key part of developing a learning environment for the implementation by welcoming challenge and involvement.
- **Systems Thinking (Senge, 1999):** The aim is to improve the whole organization, think about the system not just individual processes.
- **People (Eckes, 2001):** Remember that acceptance of the Six Sigma initiative is vital to its success. Don't forget the emotional journey that change takes people on. Help them to make sense of the proposed change, but expect some reaction to be emotional rather than purely logical. Help them to feel better about what they are losing and see the benefit in what they are gaining. Do not see people as a problem.
- **Measurement:** Measurements of deployment success often focus on numbers (number of projects completed, number of belts trained, savings to date, etc.) Goh (2010) calls this the "bigoted 'In Data We Trust' mentality". Remember to measure how people feel about the initiative too.

ie business school

#1 EUROPEAN BUSINESS SCHOOL
FINANCIAL TIMES 2013

#gobeyond

MASTER IN MANAGEMENT

Because achieving your dreams is your greatest challenge. IE Business School's Master in Management taught in English, Spanish or bilingually, trains young high performance professionals at the beginning of their career through an innovative and stimulating program that will help them reach their full potential.

- Choose your area of specialization.
- Customize your master through the different options offered.
- Global Immersion Weeks in locations such as London, Silicon Valley or Shanghai.

Because you change, we change with you.

www.ie.edu/master-management | mim.admissions@ie.edu | f t in YouTube

10.4 Steps 4 to 7: Enacting the Transformation

10.4.1 Create the Environment for Transformation

Communication of the vision is the first part of making it happen. It is important to ensure, as in the previous phase that the communication is not just one way, and that the way the strategy is deployed connects it to the local area and to what people are expected to do differently.

We need to engage a wide range of people actively in the transformation to be successful and to become active in any change people need 3 things: Will, Focus and Capability (Smith and Tosey, 1999). Traditionally, Six Sigma initiatives are good at the focus and, for Black and Green belts at least, the capability; but outside the belt community the will is often addressed only by haranguing with facts and data.

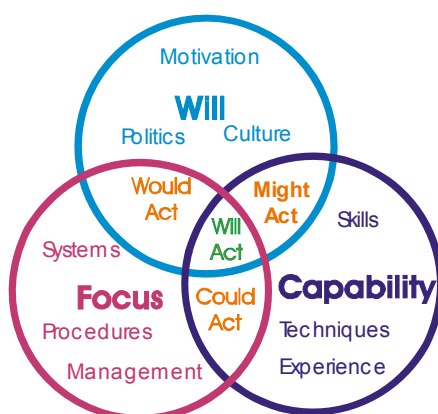

Figure 10.3. The Will-Focus-Capability model

For individuals to act they need the will, this will be bound up with their personal motivations, and the culture and politics of the organization. They also need the capability; this will mean they need to have the skills, techniques and experience that allow them to deliver change. But to make it an attractive proposition to act they must perceive that this is a priority for the organization; leaders and managers must encourage and create an environment where the desired behaviours are supported by systems and procedures as well as their own actions and statements.

Many organizations try to begin Six Sigma with a campaign to win hearts and minds and lots of training. However, if there is no immediate organizational focus on action once the training has been conducted they will lose momentum. If we stir up interest with a campaign and set up appropriate systems but fail to show people how they can make a difference then we have the kind of top-down initiative which does not work because most people don't know what action to take. Finally, unless we address changing the culture and motivating individuals, process change and training will not make much difference; they could act, but the likelihood is they will not. Remember Peters and Waterman's (2004) 'system without passion and passion without system'; neither deliver success. For an effective transformation, the three elements need to be kept in balance throughout the process.

10.4.2 Develop Improvement Projects

In chapter 5 we noted that under the Hoshin Kanri approach there are two types of improvement which might be required to achieve strategic goals, dependent on current performance, these are:

- **Breakthrough:** where significant improvements are required.
- **Incremental:** where continuous improvement will be sufficient.

Six Sigma projects are, in general suitable for the former and some ‘beachhead’ projects should be quickly set up to help deliver early and significant benefits to generate momentum. However, if this is all you do then the rest of the organization will feel side-lined, or that the initiative is not going anywhere as it will practically be invisible to them. Also begin to encourage lower level actions in respect of continuous improvement with a limited Six Sigma toolset and volunteer teams working on continuous improvement of their processes. Ensure resources are provided to support all improvement projects as an early failure will prove a large barrier to moving on with the deployment. The following is a sound process for this stage:

- **Set up initial projects:** They must be clearly linked to business and customer priorities and to closing the gaps identified in the earlier analysis. Ensure that they are also in line with staff issues to further cement the idea that this is something that staff can own and influence.
- **Identify and Train staff:** Avoid a ‘sheep dip’ approach to training all staff, this is never effective and absorbs huge amounts of resource. Train those immediately involved in projects and those who might be affected by them to an appropriate degree. Train on a just-in-time basis so that skills are used very soon after they are trained.
- **Generate quick wins:** Although projects may be systemic and long term in nature try to find quick highly visible improvements which can establish the potential and usefulness of the overall project. Publicise these quick wins.

10.4.3 Review, Measure and Evolve

Again, mindful of the principles of learning, measure the success of the process, look to build learning into individual projects as well as the wider initiative:

- **Review projects:** Make sure that progress is reviewed regularly. Encourage reflection and self-assessment in the project teams and place emphasis on honest reporting rather than meeting goals. This is important at all times, but more so in the early phases when we are learning about the deployment and need to ensure the correct approach is being taken. Encourage ‘double loop’ learning where governing ideas as well as processes are challenged.
- **Measure results:** Be honest about what results are being achieved, it is tempting to be over-optimistic to encourage acceptance, but people will soon learn the truth. Use the measures to learn; if we did not achieve what we expected to, why not, and how can we do better in the future? Never use measures to punish or reward as this will distort behaviours (see panel). Ensure measures of acceptance and feelings are recorded rather than just numerical results.

- ***Celebrate success and learn from projects:*** On successful conclusion it is important to recognise the efforts of those involved and publicise not only the benefits but also the things that have been learned.
- ***Review the initiative and realign priorities:*** on project completion it is important to update the higher level and re-assess where priorities now lie for the next set of improvement activities. Making the connection between the tactical and strategic cycles. Build on what works and modify what doesn't.

Measurement and Incentives: Goodhart's Law

Measurements and associated incentives are generally designed support the goals of the organization, and to promote behaviours which fit the company's principles. But, if not properly thought through they can have unintended consequences. Goodhart's Law say that, in general, a good measure becomes a bad measure as soon as it is treated like a target.

Aldred (2009) points to the targets for waiting times in accident and emergency units in British hospitals. This has led to some hospitals reclassifying waiting trollies as "beds with wheels" and other hospitals to request ambulances carrying patients to wait outside for a while to reduce the measured waiting time.



"I studied English for 16 years but...
...I finally learned to speak it in just six lessons"

Jane, Chinese architect

ENGLISH OUT THERE

Click to hear me talking before and after my unique course download



At this point it is entirely possible that it becomes apparent that Six Sigma does not really work for your organization. If this is the honest outcome (at whatever point in the deployment) it is a valid response to exit and try something else (Moosa and Sajid, 2010). Clearly, tenacity is required for such a major transformation, but a head-in-the-sand approach helps no-one.

10.4 Step 8: Institutionalise the New System

As Jack Welch said, Six Sigma has to be seen as integral to the organization, it has to become the way you do business. This happens in a variety of ways:

- **Talking the talk:** Managers need to ensure that Six Sigma is on the agenda at all meetings. It should become part of the key metrics of the organization and, as such be seen to drive policy.
- **Walking the walk:** Never underestimate the power of visible and active involvement of senior execs and their first line in actually doing projects, supporting training etc.
- **Embedding in daily life:** In GE Black Belts were expected to spend only 2 to 3 years in that role full time and then rotate back into management roles in the business so that, over time, more and more projects are run by qualified people within the main business structures rather than experts from the Six Sigma community.
- **Keep Measuring, reviewing and evolving:** Fuller (2000) notes the evolution of Six Sigma at Seagate into new ways of working, new areas etc. and expects this to continue. As your organization and environment evolves so should your Six Sigma initiative.

10.5 Summary

Both Six Sigma and its implementation should be a learning process (Wiklund and Wiklund, 2002). The approach presented here is consistent with both Deming's SoPK and Kotter's change model. The key thing is that it combines a consideration of the system, numbers and people in the context of learning and within a sensible process.

Review & Discussion Questions:

1. *Consider your experience of change in organizations or any relevant literature; how do change initiatives usually go wrong?*
2. *What makes for successful change?*
3. *What do you consider the most important thing about change; following a sound process or getting people's commitment? Why?*
4. *How do we best align the two?*

11 Six Sigma Projects: Key Concepts

Just as at the initiative level there are a number of key concepts which need to be understood, the same is true for the project level.

11.1 Basic Statistical Concepts

Large elements of the Six Sigma approach are statistical in nature. This text book does not purport to be a statistical text-book and so will not deal in detail with statistical tools and techniques; for a comprehensive treatment refer to “Essentials of Statistics” also available on Bookboon.com.

11.1.1 Probabilistic Thinking

In many organizations there is a tendency to think deterministically. This basically means an expectation that there will be no variation in outcomes, and that a given input (or inputs) will always generate the same output (or outputs). This flies in the face of our general life experience; we know that, for example, that a particular Olympic runner will not always beat other runners over the same distance and in the same conditions. This does not, however, stop organizations for assuming that, for example, inspection systems will always reject products of poor quality and accept products of good quality.

Thinking probabilistically allows for more effective decision making by allowing us to quantify the probability of success or failure, risk and reliability. Deterministic thinking tends to lead to overly simplistic characterisation of situations and inappropriate responses when the simplistic model fails to predict reality effectively.

11.1.2 Probability Distributions

When there are a range of possible outcomes for a given process (for example the dimensions of a manufactured product or time taken to complete a task) we can predict the probability of each outcome and thereby develop a probability distribution which models the long-term outcomes of that process. This adds a layer of sophistication to the ability to make decisions with respect to whether processes can meet design intent, or whether to give a contract to a particular supplier.

There are a number of general distribution shapes which describe situations within certain parameters. Key distributions in the context of Six Sigma are Normal, Binomial, and Poisson.

Probability calculations and distributions are handled in detail in “Essentials of Statistics” also available on Bookboon.com.

11.1.3 Descriptive Statistics

When dealing with distributions and attempting to make appropriate decisions we need to summarise what we are dealing with. This requires us to understand three key things:

- **Central Tendency:** Where is the distribution centred? This can be important in, for example, seeing if the distribution of a process is centred on the target for that process.

- **Spread:** How variable is the distribution? In general we want as much consistency as possible for a distribution.
- **Shape:** For the same central tendency and spread differing shapes of distribution would lead to different decisions.

The appropriate measures for central tendency and spread will vary with the particular measure, and the question being asked.

11.1.4. Hypothesis Testing

A key question in process improvement is ‘has something changed?’. We may ask this question in relation to deterioration of an existing process, or to establish whether an attempt to improve a process has been successful. There are a variety of tests associated with different situations and different underlying distributions, and even some which are independent of distribution. The essential question is whether the results under consideration can be explained by the natural variation within the process before the ‘deterioration’ or ‘improvement’.

A specific form of hypothesis testing relates to correlation, where we are attempting to understand whether the variation in one measure is related to the variation in another – usually as a precursor to establishing causation. For example we might be concerned with whether a change in feed rate in a metal cutting process effects a change in the surface finish of the material.

Excellent Economics and Business programmes at:



university of
 groningen



“The perfect start
 of a successful,
 international career.”

CLICK HERE
 to discover why both socially
 and academically the University
 of Groningen is one of the best
 places for a student to be

www.rug.nl/feb/education



11.2 Variation, the Normal Distribution, DPMO and Sigma Levels

11.2.1 Variation and the Normal Distribution

Variation reduction is the key mechanism for Six Sigma to deliver business benefit. By focusing on product, service or process variation (depending on circumstances) projects create consistency of performance and improved conformance to customer requirements.

Six Sigma focuses on the concept of **defects per million opportunities (DPMO)**. It uses the standard normal distribution as its measurement system. From the standard normal distribution, the mean is μ and the standard deviation is denoted by σ . From figure 11.1, 68.27% of the population lies within $\pm 1.0\sigma$ of the mean, 95.45% of the population lies within $\pm 2.0\sigma$ of the mean and 99.73% of the population lies within $\pm 3.0\sigma$ of the mean

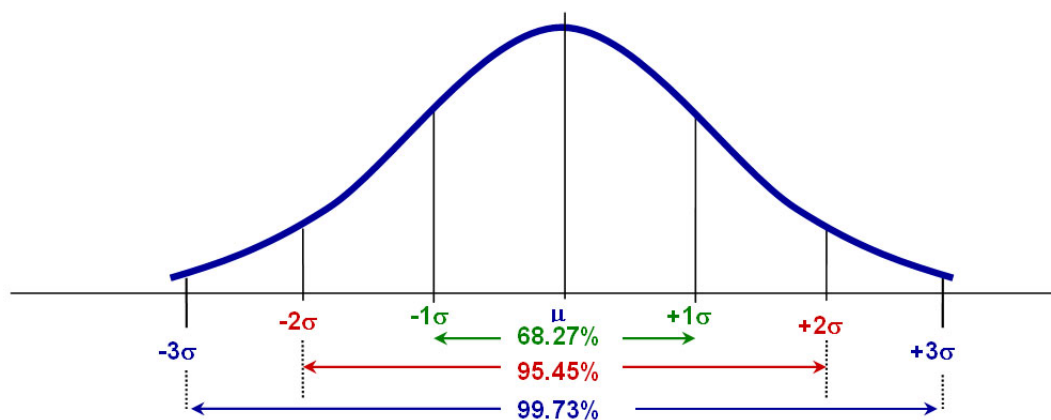

Figure 11.1. Standard normal distribution

When addressing variation it is important to remember the effects of special and common cause variation. The normal distribution and DPMO cannot apply if special causes are dominant within the process.

11.2.2 Defects per Million Opportunities

Six Sigma uses the DPMO level of a process to generate a Sigma level for the process. The idea of a Sigma level is that it compares the variation in process performance to the acceptable levels set by the customer, the higher the Sigma level the better; a Six Sigma performance indicates 3.4 DPMO.

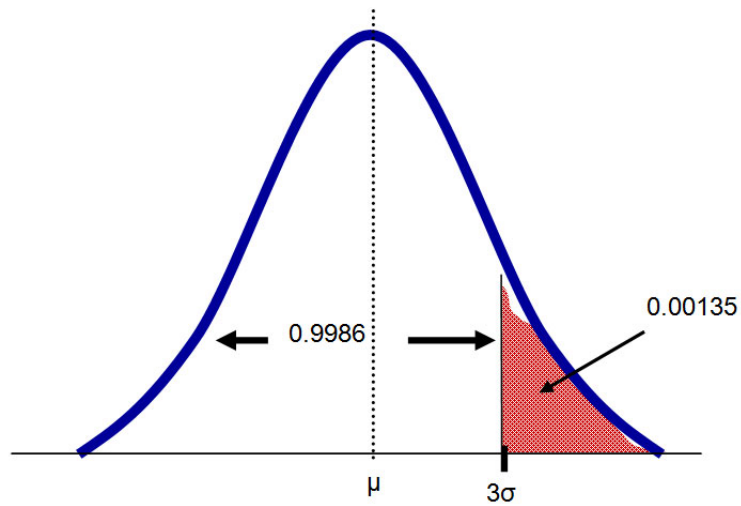

Figure 11.2. A one-sided normal distribution

So for example, from figure 11.2, when $\sigma = 3$ there are 1350 DPMO $((1-0.998)*1000000)$.

According to the standard normal distribution a process a six sigma performance would actually produce a DPMO of 0.002, but Sigma levels are calculated using an inbuilt 1.5σ shift for the process average. This is effectively an allowance for the natural propensity of processes to drift and, although debate still rages as to the validity of the exact assumption this is the commonly used approach.

The basic idea is to create a process quality metric which allows comparison of any type of process; Goh (2010) described this as one of the six triumphs of Six Sigma. The DPMO are calculated first and then translated into a Sigma value via a conversion table (see table 11.1 below).

Process Sigma	DPMO (shift=1.5 σ)	Process Sigma	DPMO (shift=1.5 σ)	Process Sigma	DPMO (shift=1.5 σ)	Process Sigma	DPMO (shift=1.5 σ)
6.0	3.4	4.5	1,350.0	3.0	66,810.6	1.5	501,350.0
5.9	5.4	4.4	1,865.9	2.9	80,762.1	1.4	541,693.8
5.8	8.5	4.3	2,555.2	2.8	96,809.1	1.3	581,814.9
5.7	13.4	4.2	3,467.0	2.7	115,083.1	1.2	621,378.4
5.6	20.7	4.1	4,661.2	2.6	135,686.8	1.1	660,082.9
5.5	31.7	4.0	6,209.7	2.5	158,686.9	1.0	697,672.1
5.4	48.1	3.9	8,197.6	2.4	184,108.2	0.9	733,944.5
5.3	72.4	3.8	10,724.1	2.3	211,927.7	0.8	768,760.5
5.2	107.8	3.7	13,903.5	2.2	242,071.4	0.7	802,048.1
5.1	159.1	3.6	17,864.5	2.1	274,412.2	0.6	833,804.3
5.0	232.7	3.5	22,750.3	2.0	308,770.2	0.5	864,094.8
4.9	337.0	3.4	28,717.0	1.9	344,915.3	0.4	893,050.4
4.8	483.5	3.3	35,931.1	1.8	382,572.1	0.3	920,860.5
4.7	687.2	3.2	44,566.7	1.7	421,427.5	0.2	947,764.9
4.6	967.7	3.1	54,801.4	1.6	461,139.8	0.1	974,042.6

Table 11.1. Process sigma table

American online

LIGS University

is currently enrolling in the
Interactive Online **BBA, MBA, MSc,**
DBA and PhD programs:

- ▶ enroll **by September 30th, 2014** and
- ▶ **save up to 16%** on the tuition!
- ▶ pay in 10 installments / 2 years
- ▶ Interactive **Online education**
- ▶ visit www.ligsuniversity.com to find out more!

Note: LIGS University is not accredited by any nationally recognized accrediting agency listed by the US Secretary of Education. More info [here](#).





The precision of the numbers in this table is something of an illusion as they are based on a perfect normal distribution which, being infinite, never occurs in practice.

DPMO Example:

If we invoice our customers for products they have bought we have a document with several fields which must be filled in correctly. On a particular company's invoices these are: Customer name, customer address, order identification number, value of goods and payment due date. There are thus 5 distinct pieces of information on the invoice and thus 5 opportunities for error (e.g. missing, incorrect, illegible) per invoice.

Last month the company sent out 1,000 invoices so that the total number of defect opportunities that month was 5,000. To establish the existing Sigma level for the process all were intercepted and inspected prior to despatch. In total 105 errors were found.

$$\text{DPMO} = (105/5,000) \times 1,000,000 = 21,000$$

Using the table above we can see the nearest match is 22,750.3 corresponding to a sigma level of 3.5. This would be the baseline for this process.

11.3 The Scientific Method and the DMAIC Cycle

Six Sigma improvement projects are structured around the scientific method, which requires that the method of enquiry based on gathering empirical and measurable data within the context of specific theories or reasoning. This is made manifest in Six Sigma in the Define-Measure-Analyse-Improve-Control (DMAIC) cycle which is the methodology through which all projects are conducted.

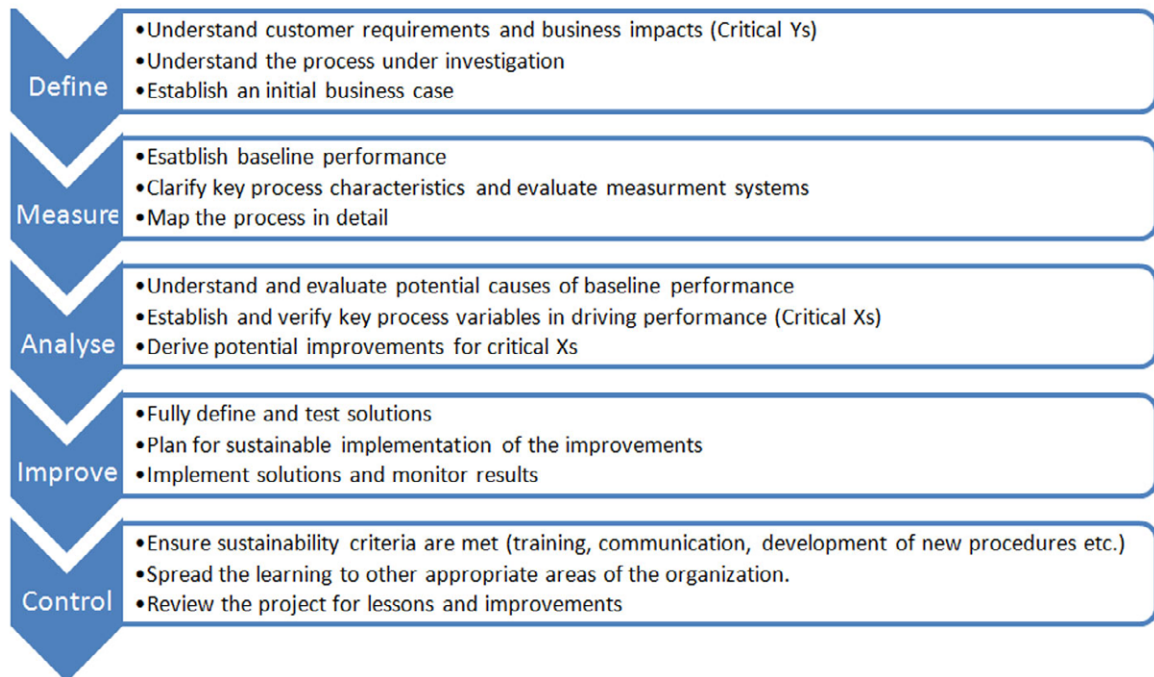

Figure 11.3. DMAIC process (based on Breyfogle, 1999; Kumar et al, 2006; Gijo and Rao, 2010)

The DMAIC cycle is perhaps best thought of as a more detailed and prescriptive version of Deming's well known Plan-Do-Study-Act cycle. The detail and prescriptiveness may in themselves be something of an issue as we shall see later.

11.4 The Four Focuses of a Six Sigma Project

11.4.1 Strategic Focus

As seen earlier, in its most useful form Six Sigma is a strategic undertaking. Chapters 5 and 10 discuss in some detail how project selection needs to be effectively linked to strategy. Black Belts are assigned projects strategically from a central committee, rather than selecting their own (which has been shown to produce poor results) or opportunistically co-opted onto projects by process owners. It behoves the Black Belt and Project Champion to be aware of the strategic context for the project in their running of it; otherwise, it is easy to be seduced into looking for short-term cost reductions instead of seeking strategic benefit.

11.4.2 Customer Focus

The voice of the customer is at the heart of the DMAIC cycle and drives much of the decision-making in the improvement projects (although it is subordinate to the strategic focus). In practice it sometimes gets subsumed into the concern with cost reduction often being seen as the key focus for Six Sigma.

11.4.3 Cost Focus

In theory at least, subordinate to the other two. Cost is the most common reporting element of a Six Sigma Project and the principal focus of most discussion and hype on the matter (Goh, 2010). This reductionist approach gives you by far the lowest long term impact.

11.4.4 Learning Focus

A learning orientation for Six Sigma is, as indicated in chapter 3 a higher order focus. There are two elements to project-based learning:

- **Intra-project learning:** which requires a reflective focus as the stages of the project progress and facilitation of the team in developing learning within the project about both the DMAIC process application and the business process on which they are working.
- **Inter-project Learning:** which requires an effective after action review as well as sharing the intra-project learning on an on-going basis.

The project based learning must be keyed in to the wider organizational learning mechanisms to deliver the full impact. As Black Belts and team members become more adept at reflecting, sense-making and developing appropriate actions they will be contributing to developing the core capabilities of the organization in learning (de Mast, 2006).

11.5 Process

For too long organizations have been obsessed with outcomes. Outcomes are driven the effective application of appropriate processes. Emphasis needs to move from assessment of outcome performance to the development and control of processes to deliver customer value. Six Sigma emphasises process over outcome and focuses on improvement of the critical process parameters to deliver excellent performance. A key aspect of a Six Sigma project is making clear and robust links between the required process outcomes ('Critical to Quality' items or 'Critical Ys' in Six Sigma terms) to the process variables which principally affect the ('Critical Xs'). This requires a reasonable depth of process understanding and rigorous testing.

.....Alcatel-Lucent 

www.alcatel-lucent.com/careers

What if you could build your future and create the future?

One generation's transformation is the next's status quo. In the near future, people may soon think it's strange that devices ever had to be "plugged in." To obtain that status, there needs to be "The Shift".



11.5 People and Change

Just as at the initiative level careful attention has to be paid to the people and change aspects, so at the individual project level this is equally important. More projects (60%) fail because of lack of attention to 'softer' aspects than any other cause (Eckes, 2001). Much of the literature focuses too much on the technical and process aspects with little attention paid to the human element (Moosa and Sajid, 2010).

11.5 Summary

The key concepts at project level, unsurprisingly, are derived from those at the initiative level. In many respects the projects are a microcosm of the bigger transformation and can contribute in similar ways, if at a more modest rate. Again we see that a narrow technical/financial focus is reductive and inhibits longer term and broader contributions.

Review & Discussion Questions:

- 1. What are the strengths and weaknesses of DPMO as a basis for, and metric of process improvement?*
- 2. Why is it important to understand both central tendency and variation in a process?*
- 3. How do we avoid a reductive approach to Six Sigma projects? And why is it important?*

12 DMAIC

12.1 Introduction

12.1.1 The DMAIC Cycle

This chapter looks at the DMAIC, which is the methodology at the centre of Six Sigma. Figure 10.1, below shows the cycle schematically.

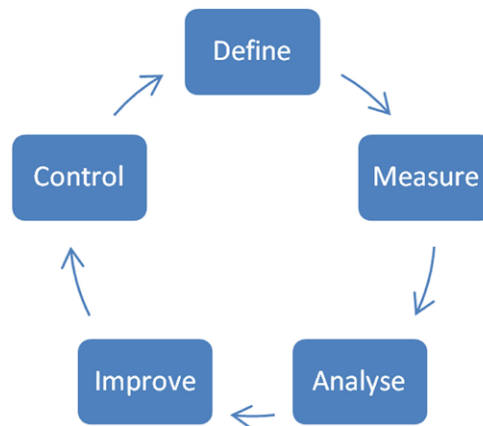

Figure 12.1. DMAIC Process

12.2 The Define Stage

12.2.1 Purpose

The Define Phase has a number of key purposes:

- **Links to The Strategic Cycle:** Firstly it links to the strategic cycle (see Chapter 5) to assess the current project against the strategic objectives and ensure that it something which has the potential to contribute to strategic goals.
- **Project Definition:** Once the project is cleared as aligned to the corporate strategy the project scope, objectives, sponsors, schedule, deliverables and team members should be identified.
- **Team Formation:** As with all change projects a team of knowledgeable and motivated individuals should be formed and supported in developing an agreed understanding of the project.
- **Assess the potential benefits:** An initial understanding of the benefits of the project (financial or otherwise) needs to be developed and agreed with sponsors. Develop measures of success relevant to this project.
- **Learn about the process:** In the define phase we need to understand how the process works and who it affects and links to; in particular customers and suppliers of the process (internal or external) need to be considered along with what they get from, or provide to the process.

12.2.2 Actions

The Define Phase has a series of interlinked actions, the numbers imply a sensible order, but this may well be an iterative process:

- **Review Strategic Plan:** Build a clear understanding of how the project contributes to organizational goals. Is this a good use of resources when considered strategically? Identify appropriate sponsors and champions to support the project. Select appropriate measures
- **Review the Opportunity:** What do the customers want? What is the current performance of the process? Realistically, what is the opportunity for improvement? Is the effort involved in improvement likely to be repaid by the benefit?
- **Canvas Support:** Build links with the people who are going to have to live with the change early in the project. Is there an appetite for change? Can changes be made in a way which is a good cultural fit with the area and create a win/win situation?
- **Form the Team:** Blend expertise in process improvement with process knowledge and ensure that aspects such as motivation and linkages to the rest of the process stakeholders are considered (leaders, whether official or de facto need to be incorporated for example).
- **Agree Timing Plan and review process:** The team need to agree the timescale for the project and conclude a rough project plan so that progress can be effectively monitored. Agree what feedback is required, to whom, and when it will occur.

Maastricht University *Leading in Learning!*

Join the best at the Maastricht University School of Business and Economics!

Top master's programmes

- 33rd place Financial Times worldwide ranking: MSc International Business
- 1st place: MSc International Business
- 1st place: MSc Financial Economics
- 2nd place: MSc Management of Learning
- 2nd place: MSc Economics
- 2nd place: MSc Econometrics and Operations Research
- 2nd place: MSc Global Supply Chain Management and Change

Sources: Keuzegids Master ranking 2013; Elsevier 'Beste Studies' ranking 2012; Financial Times Global Masters in Management ranking 2012

Maastricht University is the best specialist university in the Netherlands (Elsevier)

Visit us and find out why we are the best!
Master's Open Day: 22 February 2014

www.mastersopenday.nl

- **Learn about the process:** Gain deep knowledge of how the process works by interaction with people involved in the process and observation of the process in action. Ensure that the picture you build up is accurate by testing it with key fact holders. Clarify principal customer requirements and review the measures identified in step 1 for consistency with these requirements.
- **Streamline and Standardise the Process:** Take advantage of any 'quick wins' to ensure that obvious sources of variation and waste are removed.

12.2.3 Principal Tools and Techniques

The list is not meant to be definitive, but indicates the sort of tools/techniques which will be relevant.

- **Review Strategic Plan:** This step does not require specific tools, ideally this should be developed from the Hoshin Kanri process (see chapter 5) and comparisons with strategic objectives and action plans.
- **Review the Opportunity:** Cost of quality approaches, waste analysis, customer satisfaction questionnaires, etc. approaches to identify opportunities for improving cost, speed or customer satisfaction.
- **Canvas Support:** No specific tools required, but appropriate direct involvement with local staff. Approaches such as appreciative enquiry or stakeholder analysis might help to build support.
- **Form the Team:** Belbin team analysis may help, although the reality is often that the team will be built from the willing and the knowledgeable rather than the optimum blend of character types. Developing a project charter helps to gain commitment to the objectives and means. Ensure team members are trained and confident in the methodologies proposed for the project.
- **Learn about the process:** Use a variety of flow charting techniques to develop an understanding of the process flow (A high level process map is often useful to start with, a Supplier-Input-Process-Output-Customer Diagram helps to understand process linkages and more detailed process flow charts may be used later if required). Listening to the voice of the process will require a data collection plan, the use of appropriately selected control charts, and process capability analysis.
- **Streamline and Standardise the Process:** Simple tools such as cause and effect, pareto etc. and standard operational definitions can be used to help this process.

12.3 The Measure Stage

12.3.1 Purpose

The Measure Phase has a number of key purposes:

- **Establish Metrics and Measurement System:** What are the Critical to Quality (CTQ) elements? How should they be measured? Is the measurement system capable of discriminating to an appropriate level?
- **Listen to the Voice of the Process:** Understand present levels of performance in detail. Is the process stable? If so, what is the level of capability?

12.3.2 Actions

The Measure Phase has a series of interlinked actions, the numbers imply a sensible order, but this may well be an iterative process:

- **Select Metric and Measurement System:** Remember to review the question being asked and to generate the most appropriate measure. This may not always be as obvious as it first appear (see info box).
- **Run Control Charts:** Control charts are the only effective way of establishing whether a process is stable or whether it is under the influence of special causes.
- **Assess Process Capability (Sigma Level):** Using DPMO measures we can establish a notional sigma level for the process, or using conventional process capability approaches we can calculate a Cp or Cpk value. Of course, the assumption of normality means that we need to establish stability before either of these metrics can usefully be calculated.

Measuring Safety

Supposing we wish to measure the safety of rail travel in a particular country; there are a number of metrics which we could choose:

1. We could measure the number of deaths per departure. However, this neglects the fact that some trains carry more passengers than others, so...
2. We could measure the number of deaths per passenger journey. However, this weights short and long journeys the same, which does not seem fair, so...
3. We could measure the number of deaths per passenger kilometre travelled. However, this is confused by the fact that some trains travel faster than others, so...
4. We could measure exposure to risk by number of deaths per passenger hour on a train. However...

As you can see, we can make a cogent argument for (or against) any measure which we consider. And this is before we consider whether risk of death is the best measure of safety. Would risk of injury be better? How do we weight the different types of injury...?

Leavenworth (2011)

12.3.3 Principal Tools and Techniques

This is pretty self-explanatory, to establish process stability it will be necessary to apply some form of control chart, the actual combination selected will depend upon the situation. Measurement System Analysis or Gauge Repeatability and Reproducibility Studies would normally be associated with ensuring an acceptable measurement system is used and Process Capability Analysis or DPMO/Sigma level calculations will effectively assess the current process capability with respect to customer requirements.

12.4 The Analyse Stage

12.4.1 Purpose

The Analyse Phase has a number of key purposes:

- **Analyse the Value Stream:** What are the necessary steps to deliver value for the customer?
- **Analyse the Sources of Variation:** What are the potential sources of variation in the process for both special and common causes? How can they be verified as significant (or otherwise)?
- **Establish Key Process drivers:** What are the critical x's which contribute to the achievement of the CTQs?

12.4.2 Actions and Associated Tools

The appropriate actions for the analyse phase will depend upon the outcomes of the measure phase (obviously) and on the issue being tackled so this is a broad guide only.

- **Value Stream Analysis:** Establish the process steps which create value for the customer. Understand which elements of the existing process add value and which do not, reduce non-value add.



> Apply now

REDEFINE YOUR FUTURE
**AXA GLOBAL GRADUATE
PROGRAM 2015**

redefining / standards 

agence edis - © Photonistop

- **Analysing Sources of Variation:** Initially seek to understand all potential causes of variation by use of tools such as brainstorming and cause and effect analysis. Establish those which seem to be common and those which are likely to be special. Simple analytical tools like pareto diagrams can be used to establish the most frequent causes. More sophisticated tools such as design of experiments, correlation plots and hypothesis testing can more rigorously establish the significance of effects or relationships.
- **Establish Key Process Drivers (Sigma Level):** The same tools are used here as in bullet point 2 above.

12.4.3 Principal Tools and Techniques

Again, this is self explanatory; value stream mapping tools to support analysis of the value stream and basic or more rigorous analytical tools to investigate and validate key sources of variation and establish process drivers.

12.5 The Improve Stage

12.5.1 Purpose

The Improve Phase has a number of key purposes:

- **Determine the New Process Operating Conditions:** As an outcome of the Analyse phase the conditions are decided to provide improved performance.
- **Implement and Verify:** Ensure that the new process functions as expected and identify issues, problems and failure modes. Refine the process as required.
- **Get Buy-in from Stakeholders:** Get feedback from local personnel. Assess the likely benefits and agree with project sponsor.

12.5.2 Actions and Associated Tools

The appropriate actions for the Improve phase will depend upon the outcomes of the Analyse phase and on the issue being tackled so this is a broad guide only.

- **Process Map/Value Stream Analysis:** Establish the process steps which create value for the customer. Compare to previous process. Publish the new process and key measures.
- **Train and Test:** Train all those who require it, set up the new process and allow them to try it out. Run a pilot test. Ensure everyone is comfortable. Assess possible failure modes and address where possible.
- **Analyse Performance:** Use appropriate tools such as SPC to establish stability, hypothesis testing, DPMO etc. to understand new levels of performance. Seek feedback from local employees on how they view the new process.
- **Review and Predict:** Review data and feedback. Take improvement actions and return to step 3 as required. Predict expected performance and get buy-off from the sponsor
- **Plan for Control Phase:** Create a plan for embedding the changes and creating the opportunity for continuous improvement once the project is complete.

12.5.3 Principal Tools and Techniques

The tools are, once again, pretty clear from the previous section. Appropriate mapping techniques to communicate the new system; appropriate analytical techniques to test the system (SPC, Process Capability/DPMO, Cost of Quality analysis; Hypothesis Testing, FMEA, etc.); planning systems to ensure effective embedding of the system.

12.6 The Control Stage

12.6.1 Purpose

The Measure Phase has a number of key purposes:

- **Standardise the new process:** Document the new process, test with the staff to ensure they are happy with the solution. Train everyone and investigate opportunities to standardize across products, sites etc.
- **Create new measurement and control regime:** Set up measurement regimes which are aligned with the new process and required behaviours. Put in place control mechanisms such as SPC to ensure that improvements are maintained. Verify and re-verify the savings and benefits of the change.
- **Document lessons learnt:** No project can be completed without the team learning about both the process they are working on and the process they employed to do it. Conduct an after-action review and document lessons learnt.

12.6.2 Actions and Associated Tools

The appropriate actions for the control phase are listed below:

- **Flowchart and map process:** To clarify the new process.
- **Run workshops:** To test the solutions with the wider population.
- **Set up controls:** As required to provide on-going control.
- **After-action review:** To understand key learning points.

12.6.3 Principal Tools and Techniques

This is pretty self-explanatory; flow charts, SPC charts (of whatever type is useful) and after action reviews as required.

12.7 Summary

This chapter gives a broad overview of how the DMAIC cycle operates. It is necessarily rather mechanistic, but subsequent chapters will build on this rather anodyne base to consider specific aspects in more detail.

Review & Discussion Questions:

1. *Consider the DMAIC cycle; how would you ensure that all 3 aspects of the SoPK are considered at each stage?*
2. *What benefits might this bring over the more usual approach?*

13 Customer Focus in DMAIC

13.1 Introduction

Customer value (as introduced in chapter 6) is a central idea for quality as well as Six Sigma. Positive customer value is where the product or service they receive exceeds their expectations.

There are two essential issues within a DMAIC improvement project with respect to customers:

1. Understanding what it is the customer values from the process.
2. Understanding the value stream within the process which delivers the value to the customer.



BI

Business

Strategic Marketing Management

International Business

Leadership & Organisational Psychology

Shipping Management

Financial Economics

BI NORWEGIAN BUSINESS SCHOOL

EFMD EQUIS ACCREDITED

Empowering People. Improving Business.

BI Norwegian Business School is one of Europe's largest business schools welcoming more than 20,000 students. Our programmes provide a stimulating and multi-cultural learning environment with an international outlook ultimately providing students with professional skills to meet the increasing needs of businesses.

BI offers four different two-year, full-time Master of Science (MSc) programmes that are taught entirely in English and have been designed to provide professional skills to meet the increasing need of businesses. The MSc programmes provide a stimulating and multi-cultural learning environment to give you the best platform to launch into your career.

- MSc in Business
- MSc in Financial Economics
- MSc in Strategic Marketing Management
- MSc in Leadership and Organisational Psychology

www.bi.edu/master

13.2 What Does the Customer Value?

Customer requirement gathering is often regarded as an unfortunate necessity. This may account for the half-hearted way in which many organizations approach the task. It will often be out-sourced to market research companies, for example. Listening to your customers is probably the single most important thing you can do as an organization, you should take the opportunity to get as many of your people as possible face to face with the customer. Especially people like designers. Often we take a very uninspired questionnaire based approach, where people are asked what they want from a product or service. This may well be fine for generating 'spoken performance' requirements, but is unlikely to provide insights into 'basic' or 'excitement' features. Be creative; engage with your customer in more direct ways. Send designers to where the customer is. If you design taxi cabs, send engineers to take rides in cabs and talk to drivers about what it's like to use your product, as LTi Carbodies did. Rubbermaid's 'Customer Encounters' programme put engineers in commercial and domestic kitchens to observe their products being used.

Be The Customer: The US Air force 'Blue Two' Visit (BTV) Programme

One 'out of the box' way of understanding customer value and requirements is to put your designers into the shoes of your customers as the US Air force BTV programme does.

"The BTV program, named for the two-stripe maintainer, is designed to give corporate people, particularly designers, and Air Force Program Management personnel a first hand look at the 'real world' of supporting and maintaining systems and equipment. The participants put the same hours in as the two-stripe maintainer and get to bust their knuckles trying to loosen a bolt in a tight place or thread a nut on a bolt with Chemical, Biological and Radiological (CBR) gear on. They experience the cold and heat of a flight line. Some corporate design engineers have seen their designs in use and wondered why they designed it that way when they have the opportunity to try and work on the equipment or system."

Skinner et al (1989)

There is no single answer to the best way of gathering customer requirements, this section, and the one preceding it are designed to give a couple of examples, but mostly to alert the reader to the need for careful consideration of this area. In particular, as we saw in chapter 6 customer expectations are complex, and expressed only partially; The Kano model (Kano, 1984) shows that some elements are likely to be unexpressed by the customer. In fact there are several types of quality characteristic which can be established:

1. Attractive (A) – Equivalent to excitement Quality in the diagram
2. One-Dimensional (O) –Equivalent to Spoken Performance in the diagram
3. Must-be (M) - Equivalent to Basic Quality in the diagram
4. Indifferent (I) – Shown by blue circle
5. Reverse (R) - Shown by red line

Indifferent is where customers don't really mind if they have the requirement or not; reverse is where they prefer not to have it.

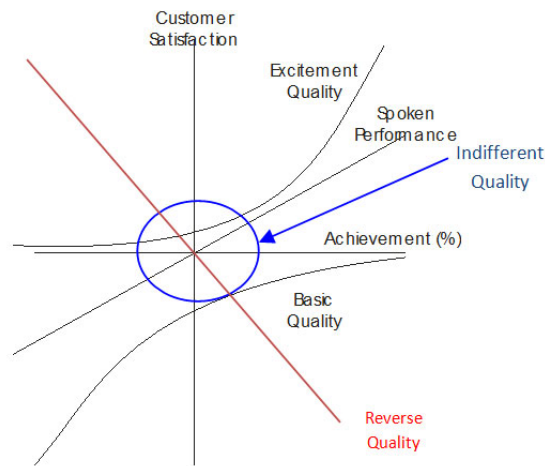

Figure 13.1. The modified Kano model of quality (adapted from Lee et al, 2011)

Requirements can be categorized by asking customers how they feel about the presence of a feature and the how they feel about its absence. Table below shows how to interpret results:

	Not Present				
Customer Requirement	Like	Must Be	Neutral	Live With	Dislike
Like	Q	A ₁	A ₂	A ₃	O ₁
Must Be	R ₁	I ₁	I ₂	I ₃	M ₁
Neutral	R ₂	I ₄	I ₅	I ₆	M ₂
Live With	R ₃	I ₇	I ₈	I ₉	M ₃
Dislike	R ₄	R ₅	R ₆	R ₇	Q

Table 13.1. Kano evaluation sheet (Lee et al, 2011)

Dependent upon the results the requirement is categorized into one of the 5 categories or Questionable to indicate where the customer appears to like both presence and absence. This allows the team to understand not only what the customer wants, but what kind of requirement they are. This allows for a much more subtle understanding of requirements. This may not be necessary for projects where requirements are clear but is helpful when the situation is more complex. As the box shows, though, even seemingly simple situations can be complex.

Customer Requirements: Unspoken Needs

Even with internal customers requirements are not always obvious. In a process within a pharmaceutical company process X supplies Process Y with powder in bulk form (drums) to decant into single dose phials for transport to the customer.

Process Y specifies an acceptable particle size range, with which Process X complies. However, on smaller dose phials Process Y experiences fill accuracy problems.

On inspection, it is apparent that not only particle size is important but also aspect ratio; this affects the propensity of the particles to cohere and adhere, and how much air is contained within the powder, not a problem for large phials, but crucial for small ones.

Once the problem was understood the unspoken requirement became spoken and Process X complied with ease.

13.3 What is the Value Stream?

13.3.1 Supplier-Input-Process-Output-Customer Model (SIPOC)

The SIPOC is a crude value stream for the process. It identifies who supplies what to the process, and who gets what from the process. This allows the team to understand how value flows through the process to the identified customers of the process (internal or external).

Need help with your dissertation?

Get in-depth feedback & advice from experts in your topic area. Find out what you can do to improve the quality of your dissertation!

Get Help Now



Go to www.helpmyassignment.co.uk for more info



Suppliers: Sugar supply Flavouring supply Active Ingredient supply Methods Eng'g	Inputs: Sugar Flavouring Citric Acid Active ingredients Methods sheets						Process: Name: Medicated sweet production Purpose: Deliver medicated sweets Owner: CT	Outputs: Medicated sweets	Customers: Wrapping process Shops Consumers
Process Steps							Measures	Customer Needs	
	Cook mixture	Cool Mixture	Form rope	Size rope	Form sweets	Cool sweets	Rejects COGS Downtime		
Process Measures	None	None	None	None	None	Sweet size			
Present Data	None	None	None	None	None	Shown later			
Goal Performance	None	None	None	None	None	None			
Sources of Variation	Raws Mixing Rework	Temp Viscosity Drum speed	Folding Speed temp	Temp Viscosity speed	Head Temp	None			
Impact on Performance	Size Brittleness	Size Brittleness	Size Air inclusion	Size	Size waste	None			

Figure 13.2. Example of a SIPOC (See chapter 20 for context)

By understanding additional information such as measures currently in place, sources of variation and present performance the team can begin to understand what aspects of the value stream have the potential to impact the outcomes. See the example in figure 13.2.

13.4 What Design/Process Elements Affect Customer requirements?

It may be helpful to investigate the voice of the customer and how it interacts with the process in more detail. In this regard, a particularly useful technique is Quality Function Deployment. This technique may be used to look at product, process, or service elements.

13.5 Quality Function Deployment

Quality Function Deployment (QFD) theory was first defined and applied at the Kobe shipyard of Mitsubishi when they began to use a matrix that put customer demands on the vertical axis and the methods by which they would be met on the horizontal axis.

The system has developed from this simple basis to encompass the broad range of activities within most manufacturing organizations. The comprehensive application of the technique has been defined thus:

“A system for translating customer requirements into appropriate company requirements at every stage, from research through product design and development, to manufacture, distribution, installation and marketing, sales and service.”

It is equally valid to think of QFD as a way of identifying the **true** voice of the customer at an early stage and making sure that it is heard all the way through the design-production-delivery process to achieve high levels of customer satisfaction.

One of the most important things to recognise about QFD is that it is **not** a quality technique. It is basically a planning tool used to focus effort where it really matters; on customer satisfaction. This is the role it may play in Six Sigma projects.

The Quality Function Deployment logic and matrix (sometimes called The House of Quality) can be as easily applied to a service organization as to a manufacturing one. The technique would be the same; only the titles of some of the matrices would be different.

13.5.1 Customer requirements in QFD

We must establish what the customer is actually saying to us. This will often be in his own words, which may not lend themselves to action within the organization. Customers might want a car to be “Aesthetically pleasing”, or “Sound nice” or to “Handle well”. The present reaction to such information would be to interpret what we think the customer means by these imprecise statements. This is wholly wrong and puts us at risk of starting off with a largely spurious set of requirements. The correct response is to interrogate the customer further to ensure that you fully understand what exactly each of these statements means.

In QFD the process of interpreting broad, and usually somewhat vague, requirements into ones that are more meaningful to the organisation is known as producing primary, secondary and tertiary requirements. An example of this for seats in a passenger aeroplane is shown in Figure 13.3 below.

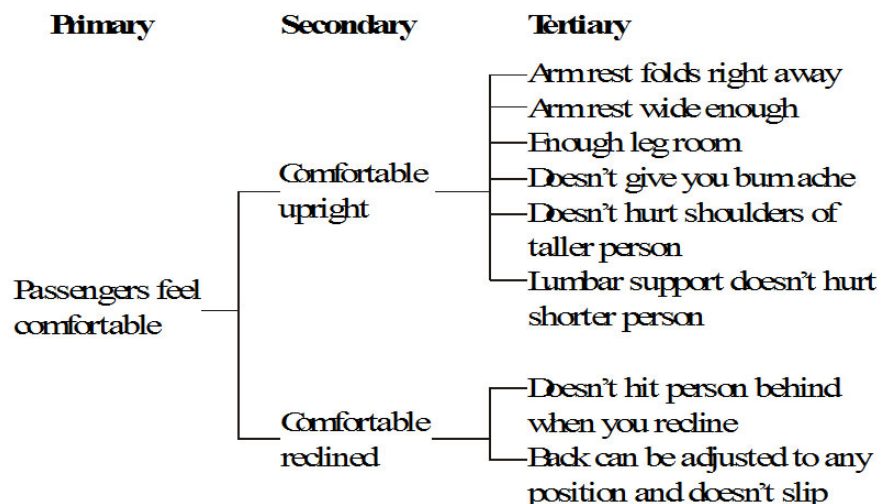

Figure 13.3. Primary, secondary and tertiary requirements (partial) for an aircraft seat.

The primary requirements are the top level of definition whilst tertiary requirements are at the lowest level of detail possible. We wish to deal with tertiary requirements since these are most closely related to the actions we as an organisation can take to satisfy customers.

Remember that prior to applying QFD we can apply Kano's logic to establish what type of requirements we are dealing with.

13.5.2 The QFD Process

Once we have established the requirements we can begin to build up the first QFD matrix. The matrix is used to analyse the complex relationships between the customer requirements of the final product or service and the engineering or service characteristics that will meet these requirements. This can be seen as the relationship between what we are going to do and how we are going to do it.

This translation of the voice of the customer into language meaningful to the designer of the product or service is a very important step in the QFD process and should be studied and carried out carefully to ensure that this voice is not distorted. We must be careful at this stage not to assume that what we are currently doing is right, this is a time to be creative in our examination of each of the requirements whilst always remembering to confine this creativity to how we respond to the requirement and not how we wish to interpret it.

Figure 9.3 shows the basic matrix for the customer requirements of a passenger aeroplane seat. The requirements shown are purely those of the traveling passenger.



Brain power

By 2020, wind could provide one-tenth of our planet's electricity needs. Already today, SKF's innovative know-how is crucial to running a large proportion of the world's wind turbines.

Up to 25 % of the generating costs relate to maintenance. These can be reduced dramatically thanks to our systems for on-line condition monitoring and automatic lubrication. We help make it more economical to create cleaner, cheaper energy out of thin air.

By sharing our experience, expertise, and creativity, industries can boost performance beyond expectations. Therefore we need the best employees who can meet this challenge!

The Power of Knowledge Engineering

Plug into The Power of Knowledge Engineering.
Visit us at www.skf.com/knowledge

SKF



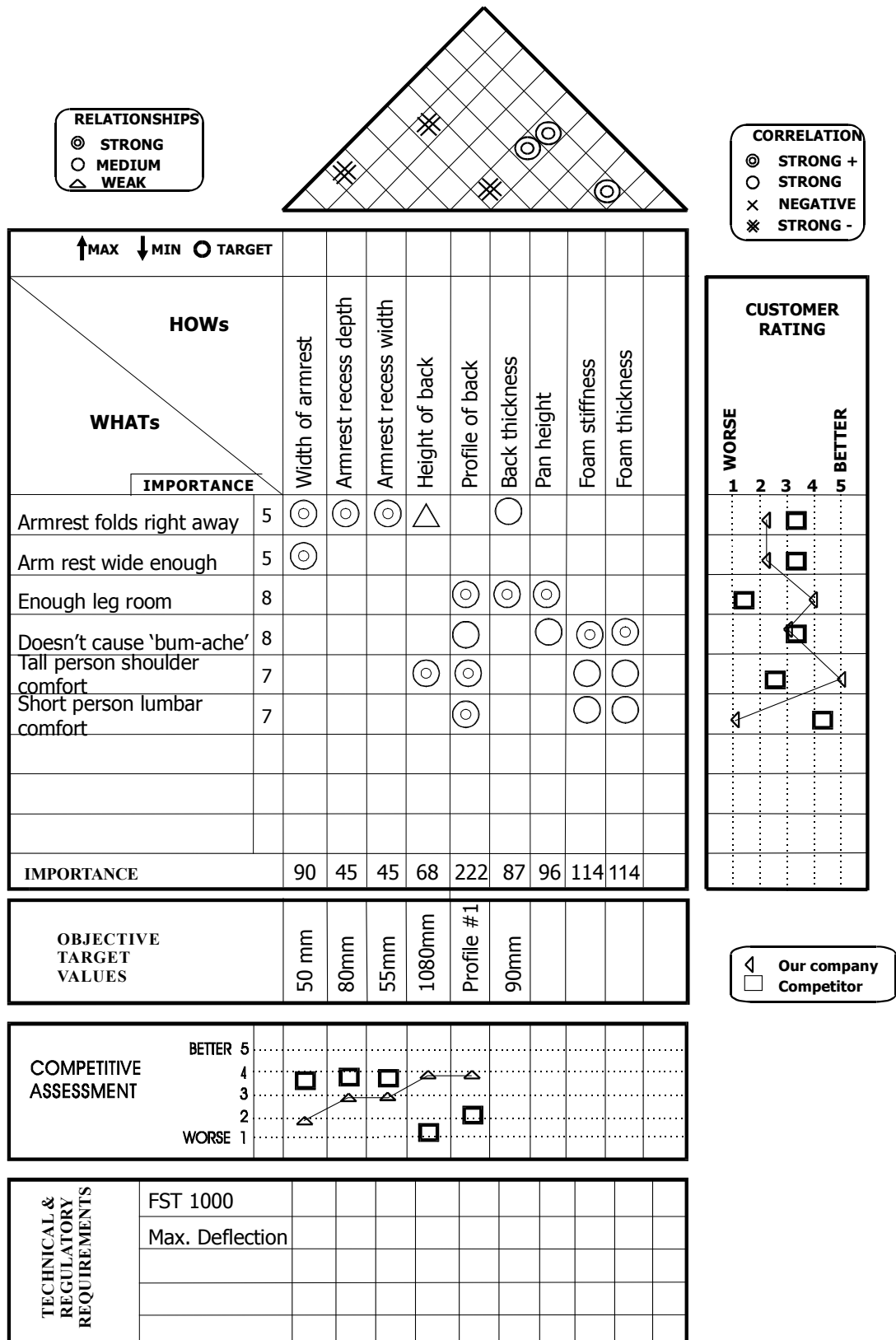

Figure 13.4. The QFD matrix.

The salient features of the matrix are as follows:

The customer requirements: shown down the left hand side of the matrix and denoted as the ‘whats’.

The design requirements: shown across the top of the matrix and denoted as the ‘hows’. These represent what we can control as designers.

The relationship matrix: representing all possible relationships between ‘whats’ and ‘hows’. Each location represents a particular ‘what’/‘how’ combination. The relationships can usually be ascertained using logic, engineering judgement and experience. Where the relationships are unclear, or disputed a more scientific approach such as design of experiments may be used.

The relationship symbols: a blank indicates no relationship exists, a triangle that only a weak relationship exists, a circle that a medium-strength relationship exists and a double circle that a strong relationship exists.

The ‘what’ importance ratings: shown down the left of the matrix these are numerical representations (on a scale of 1 to 10 in this case) of the importance to the customer of each requirement.

The ‘how’ importance ratings: these are generated from the ‘what’ importance ratings and the relationship strengths. This gives an overall value as to the things we do which are most important to get right from the customer’s point of view.

The relationships are given numerical values according to their strength. These values are shown in the diagram above. The importance of each ‘how’ is the sum of its importance to each of the individual ‘whats’. It can clearly be seen that the relationship between each particular ‘how’ and the ‘what’ has a multiplicative effect. Thus, for ‘width of armrest’ in column one we can do the following calculation.

Its importance to achieving the requirement ‘armrest folds right away’ is:

$$5 \text{ (importance rating)} \times 9 \text{ (relationship rating)} = 45$$

Similarly for the requirement ‘arm rest wide enough’ the importance is 45.

Since these are the only two requirements upon which the width of the arm rest has an effect we need not calculate any further and by summing the effects it does have (i.e. the numbers above) we get an overall importance rating, in this case 90. It is important to note that this figure is only valid within the study and for comparison purposes only. It gives a pecking order to the activities we can pursue should they conflict but does not remove the drive to optimize all parameters.

The triangular matrix that has been added at the top of the diagram is known as the correlation matrix since it is concerned with identifying inter-relationships between the design requirements. It is read by reading right up the appropriate angled column from the left-most requirement of the two under consideration and left from the other until the two columns meet. At this point there can be one of four symbols (or no symbol at all), indicating both the nature and strength of the inter-relationship. We can see two distinct types of relationship here:

Synergistic: where two ‘hows’ each have a positive effect on the achievement of the other.

Trade-off: where two ‘hows’ each interfere with the achievement of the other.

Each of these relationships may be characterized as strong or weak as indicated in the legend of the figure above. We can see, for instance, that there is a synergy between ‘profile of the back’ and ‘foam stiffness’, whilst ‘profile of back’ and ‘back thickness’ require a trade-off. Both of these relationships are strong.

The benefits of this part of the QFD matrix are that it is possible to pick up trade-offs and synergies at a very early stage in the design process. It is important to note that all trade-offs must be made in favour of the customer (i.e. in favour of the highest overall importance rating). A more pro-active way to look at trade-offs is to try to move technical abilities on to the stage where the trade-off is avoided.

The objective target values; we know how important it is for a feature to be right but we need to define, if we can, what exactly we mean by right. Secondly there are two comparison tables, which we can use to assess how good we are at present, or how good our proposed design is, these are:

Customer rating: how does the customer perceive our performance as against our competitors on each of the requirements? The data for this assessment must come from customers, not be assumed.

Competitive assessment: How do we compare to our competitors against the objective target values we have set ourselves on the design requirements? This is a technical assessment carried out in house by those involved with the service or product.

The assessments allow us to establish several things:

- Where we are ahead and need to maintain the lead
- Where we lag and need to catch up
- Where there is a gap in the market.

"I studied English for 16 years but...
...I finally learned to speak it in just six lessons"
Jane, Chinese architect

ENGLISH OUT THERE

Click to hear me talking before and after my unique course download

Once we have reached this stage in the assessment we can come to a series of decisions about what needs to be done in terms of design of the service or product to ensure customer satisfaction. We can rank in order of importance what needs to be got right and we can compare ourselves with our competitors both from the customers' viewpoint and in technical terms to see where the best business opportunities lie.

There are several neat checks within the QFD process to ensure that our thinking does not go off track. If we see an empty row in the main matrix, we know that there is a customer need that is not being attended to by what we are doing, if we see an empty column it would appear that we are pursuing some activities that do not appear to be focused on the customer. When we get to the assessment stage we can look for inconsistencies between the two measurements, this means that if we are rated poorly by the customer on a particular requirement we would expect to be rated poorly on the factors affecting that requirement in the technical assessment. If this were not the case we would have to assume the customer point of view to be correct and reassess our understanding of the relationships or of the appropriate target values.

13.5.3 The Expanded QFD Process

The matrix that has been discussed in some detail so far is the first level of the full QFD process. This would generally be sufficient for an improvement project, however, if we were starting to design a new product or service, we would wish to ensure that the voice of the customer is cascaded throughout the whole company we can extend the QFD process to include other parts of the product lifecycle. Figure 13.5 is a schematic of how this can be done including the names given to each part of the process.

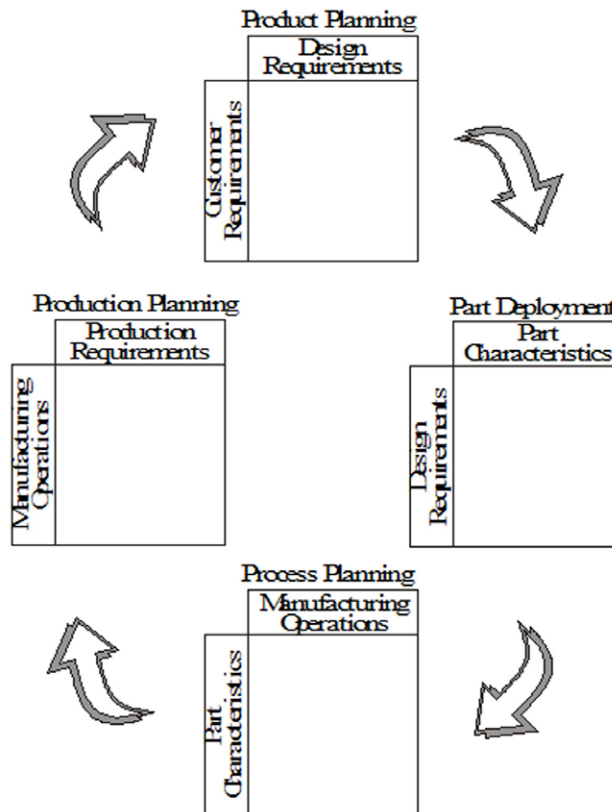

Figure 13.5. The Expanded QFD process.

Part Deployment: This matrix is concerned with identifying the critical component characteristics to support the design requirements established in the previous matrix. As shown above the ‘Hows’ from the previous matrix become the ‘Whats’ in this one.

Process Planning: The process planning matrix allows critical processes to be identified which are key to the successful production of the product. This stage is designed to determine critical process operations and critical process parameters. As before the ‘Hows’ from the previous matrix become the ‘Whats’ in this one.

Production Planning: This chart is designed to ensure the smooth transition from development into manufacturing. In this house we aim to minimise controllable variations in the manufacturing processes. As before the ‘Hows’ from the previous matrix become the ‘Whats’ in this one.

13.5.1 Using The Results

Once we have a clear view of what process elements need to be controlled to deliver the requirements this should provide the steering mechanism for the rest of the improvement projects. We can then understand what drives variation in the Critical Xs so identified and begin to tackle improvement in them, with confidence that these will drive the customer requirements.

When improvements have been made, then we return to the customer requirements to observe the impact which has been made.

13.6 Summary

To be customer focused improvement projects need to identify and understand what it is the customer values and develop a clear view of what product, service or process elements drive performance (and hence value) in those requirements.

Review & Discussion Questions:

- 1. What are the benefits of understanding the Kano designation of customer requirements?*
- 2. How do the designations affect priority? Consider how this prioritization might be affected by company strategy and market position.*
- 3. Take a simple process with which you are familiar and apply QFD to it. What difficulties do you encounter, and how could they be dealt with in a real-life application?*

14 Variability Reduction in DMAIC

14.1 Introduction

The second key focus of the DMAIC project is the reduction of variation. As we have already seen, variation drives waste and cost in organizations and reducing it will result in increased customer satisfaction as well as financial benefit. The goal for an effective process is to be on target with minimum variation. Broadly speaking variability reduction has 3 phases:

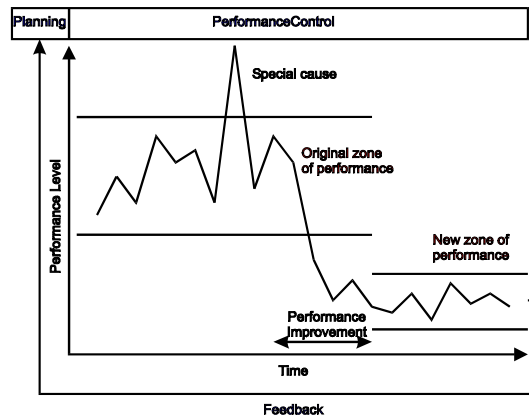

Figure 14.1. Juran's Quality Trilogy (Modified from Defoe and Juran, 2010).

What do you want to do?

No matter what you want out of your future career, an employer with a broad range of operations in a load of countries will always be the ticket. Working within the Volvo Group means more than 100,000 friends and colleagues in more than 185 countries all over the world. We offer graduates great career opportunities – check out the Career section at our web site www.volvogroup.com. We look forward to getting to know you!

VOLVO
AB Volvo (publ)
www.volvogroup.com

VOLVO TRUCKS | RENAULT TRUCKS | MACK TRUCKS | VOLVO BUSES | VOLVO CONSTRUCTION EQUIPMENT | VOLVO PENTA | VOLVO AERO | VOLVO IT
VOLVO FINANCIAL SERVICES | VOLVO 3P | VOLVO POWERTRAIN | VOLVO PARTS | VOLVO TECHNOLOGY | VOLVO LOGISTICS | BUSINESS AREA ASIA

- **Planning:** The planning phase should be driven by the learning from previous product, process or service implementations. We plan the new system in the light of what we learnt improving the previous one so that it should be closer to the improved state rather than the original.
- **Control:** In the control phase we learn about the new product, service or process performance by monitoring variation and establishing a stable baseline performance by removing special causes.
- **Improvement:** Once the process is stable, we have a basis to experiment. We can reduce the common causes of variation to produce an improved stable zone of performance; nearer to target and with reduced variation. The learning from this phase should feed back into the planning phase for future products, services or processes.

14.2 Building and Using Control Charts

Six Sigma DMAIC projects start with an established process, so the first thing to do is to establish the current level of performance and stability. The only effective way is to use control charts, an approach pioneered by Dr. Shewhart in the late 1920's and, although understanding has developed a little since then, the basic approach has remained intact. This section of the notes explains the appropriate approaches to generating process learning from Shewhart's approach to charting.

14.2.1 Run Charts: The First Step

The first step in putting data into context is to see it as part of the history of the process. This is best achieved by the use of run charts. Such diagrams (see below) allow judgements to be made about process trends or shifts. They often also compare the current status of the process to the target or budget associated with that process.

Whilst it can easily be seen that this is a significant improvement on making judgements based on the comparison of two adjacent points it is still not particularly scientific. Questions arising from such charts might include: when is a trend significant? How much of a shift has to occur before we act? How does the target relate to the actual performance of the process?

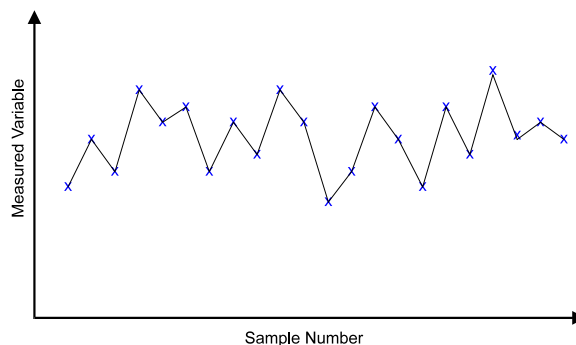

Figure 14.2. Run chart

14.2.2 Shewhart Charts: Application of Economic and Scientific Principles

The lack of convincing answers to these questions shows the vulnerability of this approach. Shewhart uses the empirical rule for homogenous data to set up rules by which we can make consistent judgements about changes in the process.

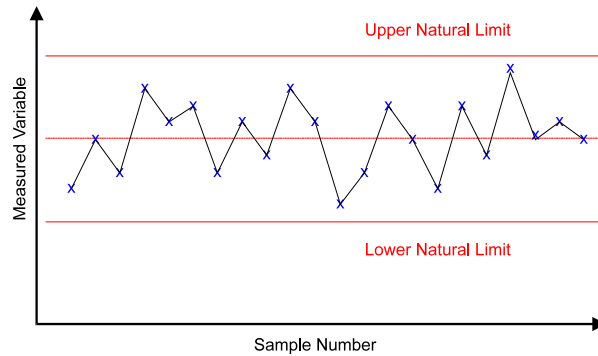

Figure 14.3. A control chart

The concept of natural limits for a process means that we can distinguish significant changes from insignificant ones: Special Causes from Common Causes of variation. Since the decision rules are based upon characteristics of all homogenous data sets rather than the specific attributes of one particular distribution this is a very robust model.

Note that texts which claim that control charts are based upon the normal distribution and the central limit theorem are moving away from the original work conducted by Shewhart and are, in fact, not following consistent logic. For example, whilst the central limit theorem works for the average chart it does not apply to the range charts for the subgroup sizes typically used, nor can it apply to the individuals chart where there are no subgroup averages for the theorem to apply to.

Shewhart's general approach to process control is to take a subgroup of the data and extrapolate from the results of this subgroup to make predictions for the population. The two elements of the subgroup to which control are applied are the average and the range. It is appropriate at this point to discuss the relative roles of these two elements.

14.2.3 Role of the Average Chart

The average chart is concerned with variation between subgroups. The control limits are based upon 3 sigma for the subgroup average distribution. They are essentially testing if individual subgroup averages vary more than could be expected given the variability within individual subgroups. To this end the control limits are calculated using the average range of subgroup data as an estimate of this short-term variability.

14.2.4 Role of the Range Chart

The range chart is concerned with variation within subgroups. The control limits are based upon 3 sigma for the subgroup range distribution. They are essentially testing if the variation within each subgroup is similar to the variation within the other subgroups. To this end the control limits are calculated using the average range of subgroup data as an estimate of this within subgroup variability.

14.2.5 Rational Subgrouping

There is a requirement which underpins the application of the average and range chart. The requirement is known as 'rational subgrouping'. Since the control limits of the average chart are calculated using subgroup range data we are assuming that the range of a subgroup is a reliable estimate of short term variability. If the subgroup range is regularly distorted by special causes then the control limits will be distorted leading to incorrect decisions.

We need to select subgroups in such a way as to minimise this possibility and ensure homogeneity within the subgroup. The best way of achieving this is to select them so that they are produced at approximately the same time –usually consecutively within the process. However, rational subgrouping is also about thinking about the context for the data. What are the sources of variation present? What questions are the charts addressing? Specifically, any natural subgroups which occur within the data need to be considered. If you ignore a natural subgroup and force the data into another pattern you will be creating irrational subgroups which will distort the process control.

Inappropriate subgrouping is a particular issue with data which naturally occurs in a subgroup size of one. Examples of this might include monthly values (e.g. sales figures), periodic measurements from a continuous process or final test values for a series of complex products. If we accept the statistical wisdom that control charts only work because of the central limit theorem we would group the data, but if we group together, for example, five consecutive months of sales data because there would be a virtual certainty that a special cause would intervene within the subgroup (promotions, product launches, etc.). This would distort the calculated control limits and lead to poor decision making.

qaiteye[®]
Challenge the way we run

**EXPERIENCE THE POWER OF
FULL ENGAGEMENT...**

**RUN FASTER.
RUN LONGER..
RUN EASIER...**

**READ MORE & PRE-ORDER TODAY
WWW.GAITEYE.COM**

14.2.6. Calculating Control Limits

In order to establish whether the process is in control we need to apply a statistical test. In the case of control charts this is the control limits. Shewhart has set down methods of calculation for the control limits for each of the charts. These are based on the assumption of 3 sigma limits for both average and range charts.

It is worth noting that the choice of 3 Sigma is an economic rather than a statistical one (Shewhart, 1980). At this level he considers that it would be economic to find and fix the causes of any point outside the limits but uneconomic to do the same for points inside the limits.

14.2.7. Calculations for the Average Chart

The following are the key calculations for the average chart. First Calculate the process average, then the average range:

$$\bar{\bar{x}} = \frac{\sum \bar{x}}{n}$$

$\bar{\bar{x}}$ = Process (grand) average
 \bar{x} = subgroup average
 n = number of subgroups

$$\bar{R} = \frac{\sum R}{n}$$

\bar{R} = Average range
 R = Subgroup Range

These two form the centre lines for the two charts. The control limits for the average chart are calculated as below:

$$UCL_{\bar{x}} = \bar{\bar{x}} + A_2 \bar{R} \quad LCL_{\bar{x}} = \bar{\bar{x}} - A_2 \bar{R}$$

$$UCL_{\bar{x}} = \text{Upper Control Limit } \bar{x} \quad LCL_{\bar{x}} = \text{Lower Control Limit } \bar{x}$$

Draw the chart with the associated control limits.

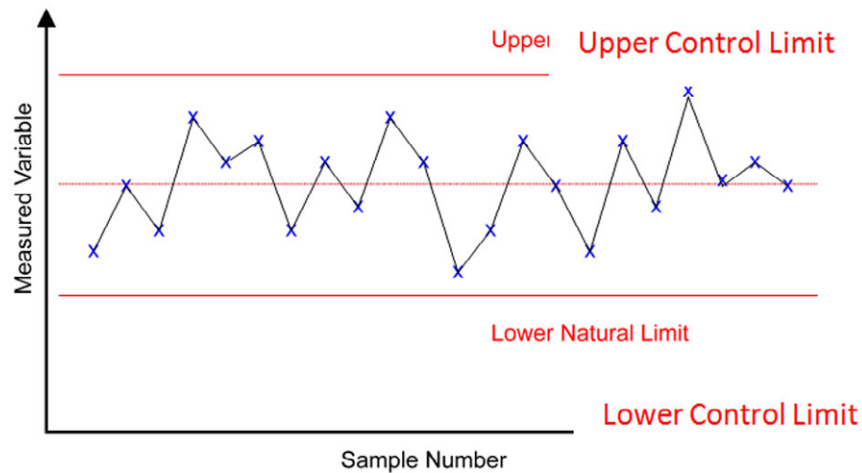

Figure 14.4. Average chart

14.2.8 Calculations for the Range Chart

The Control limits for the range chart are calculated as below:

$$UCL_R = D_4 \bar{R} \quad LCL_R = D_3 \bar{R}$$

$UCL_R =$ Upper control limit for R $LCL_R =$ Lower control limit for R

As above, draw the chart.

The values of the proportionality constants for given subgroup sizes can be found in standard texts but are listed below for reference:

n	A ₂	D ₃	D ₄	n	A ₂	D ₃	D ₄
1	-----	-----	-----	7	0.419	0.076	1.924
2	1.680	0.000	3.267	8	0.373	0.136	1.864
3	1.023	0.000	2.574	9	0.337	0.184	1.816
4	0.729	0.000	2.282	10	0.308	0.223	1.777
5	0.577	0.000	2.114	11	0.285	0.256	1.744
6	0.483	0.000	2.004	12	0.266	0.283	1.717

Table 14.1. Constants of proportionality

14.2.9 Out of Control Conditions

The purpose of calculating the control limits is to support the identification of out of control conditions and subsequent process learning. We require rules to indicate when a process is out of control. The control limits provide one indication of significant shocks to the system but further rules are required in order to provide more confidence in the ability of the charts to detect smaller shifts or drifts in the process. There are several approaches to this but we are going to concentrate on the most common set of rules which are known as ‘The Western Electric Detection Rules.’ These are below:

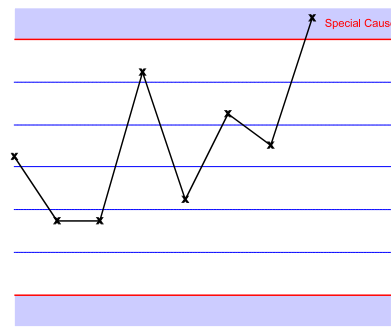

Figure 14.5. Rule 1: A single point falls outside the 3 sigma control limits



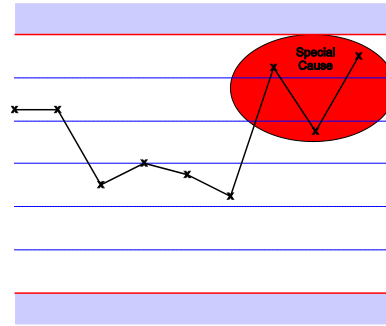

Figure 14.6. Rule 2: At least 2 out of 3 consecutive values fall on the same side of, and more than 2 sigma units away from, the central line

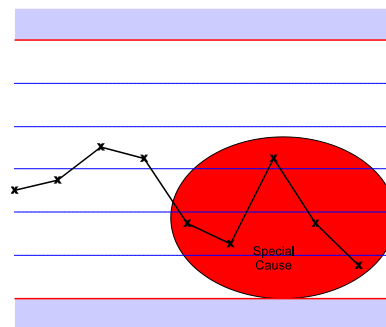

Figure 14.7. Rule 3: At least 4 out of 5 consecutive values fall on the same side of, and more than 1 sigma unit away from, the central line

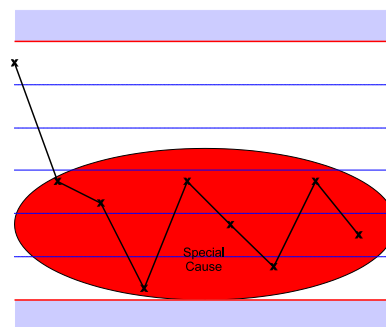

Figure 14.8. Rule 4: At least 8 consecutive values fall on the same side of the central line

It is suggested that for simplicity it may be easier to introduce the charts with only rules 1 and 4 being considered as they require no extra calculations. Whilst it is possible that this would lead to some out of control points not being spotted, it may be sensible to keep matters as simple as possible early in the introduction. When the organisation is comfortable with the application of these two simple rules then the more complex rules 2 and 3 can be introduced for more sensitivity and quicker response. The key thing to remember is that it is more important to inculcate the *approach* to process improvement which underpins SPC than to spot every special cause in the initial phases.

It is also worth remembering that these are generic rules which work well for a wide variety of processes. They are clearly not comprehensive but reflect a good compromise between sensitivity to special causes and usability in real-life situations. In companies where their use of data is more sophisticated and experience of using SPC is greater it is possible to observe the customisation of out of control rules for different processes. For example the following pattern might be observed in a sheet extrusion process, where sheet thickness is the quality characteristic being measured.

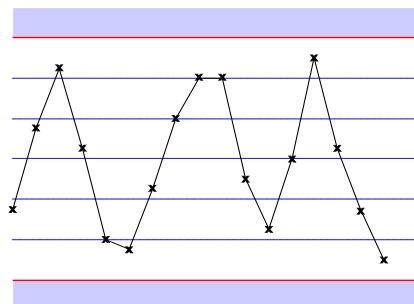

Figure 14.9. Non-random pattern: Cycling

There is clearly a cyclical pattern emerging. Is this, however, truly a special cause? To answer this question accurately we shall need to carefully link the observed pattern to process knowledge. In this case relevant information is that the machine operates by having an automatic sensor periodically measuring the sheet thickness and using this data to provide feedback to a controller which adjusts the speed of the extrusion screw in response to the readings. The pattern could represent the tendency to over-adjust for common cause variation. An appropriate confirmation strategy might be either to turn the controller off and observe the result or reduce the gain on the controller to increase the variation in sheet thickness required to initiate a response.

Other potential out of control indicators might be 'hugging' the central line (remember we expect only 60% to 75% of the plot points to fall within ± 1 sigma unit) which could indicate poor control limit calculations or lack of rational subgrouping so that special causes within the subgroup range have had the effect of inflating the control limits. In short, any unusual patterns might be worth investigating for correlation with features of the process.

We do, however, need to take care to avoid the phenomena of operators responding to points or combinations of points because they 'do not like them' rather than because they indicate the presence of a special cause within the system. Remember; never respond to an unusual pattern unless you can link it to a process cause. The other thing to remember is that the zeal with which you investigate patterns will be limited by resources. In the case of limited resources, or early in the application where failure to find a special cause may lead to reduced credibility you may wish to stick to the Western Electric Rules.

14.2.10 Tampering

Tampering is a phenomenon which is all too common in manufacturing processes. It is the act of responding to special causes as if they were common causes. A typical example of this is when an operator takes samples from the process and measures them to ensure that the process is operating satisfactorily. He has a process tolerance which he has to maintain, understanding that there is a little variability in the process he knocks 10% off each tolerance limits and adjusts the process if the sample he takes is outside of his 'preferred' limits. However, if the natural spread of the process is exactly equal to the process tolerances then samples can breach these natural limits without a special cause being present. If the process set precisely on nominal then the process is in its best possible condition. Consider the case when a point falls outside the 'preferred' limits with the process in its optimum condition.

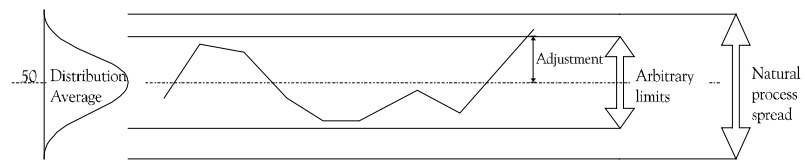

Process reset based on arbitrary action limit (tolerance based).

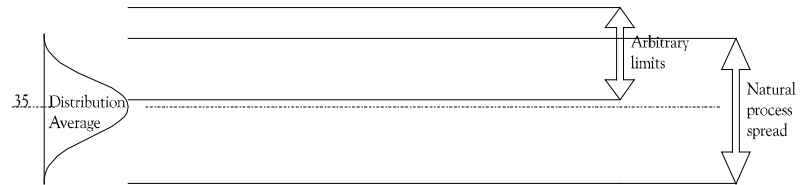

The resulting mismatch of requirements will lead to more and opposing adjustments, introducing more and more variation into an originally stable situation.

Figure 14.10. Tampering

The operator will adjust the process to ‘re-centre’ it. This will necessarily make matters worse, and it will make it even more likely that the ‘preferred’ limits will be broken on the opposite side. When adjustment is made for this the process will swing in the opposite direction and so on, ad infinitum. By his/her well-meaning interventions the operator has ensured that the process will never achieve its optimum condition and, in fact, it is likely that the variation will be significantly worse than it would be if he/she just let the process run!

www.sylvania.com

We do not reinvent the wheel we reinvent light.

Fascinating lighting offers an infinite spectrum of possibilities: Innovative technologies and new markets provide both opportunities and challenges. An environment in which your expertise is in high demand. Enjoy the supportive working atmosphere within our global group and benefit from international career paths. Implement sustainable ideas in close cooperation with other specialists and contribute to influencing our future. Come and join us in reinventing light every day.

Light is OSRAM

OSRAM SYLVANIA



The rule is that adjustments and changes should not be made without knowledge. True process knowledge ('profound knowledge' as Deming refers to it) can only be obtained by the consistent and assiduous application of control charting principles.

It is also worthy of note that tampering is rife in non-manufacturing and boardroom areas too. How often do boards of directors think that it might just be common causes of variation when sales drop, absenteeism rises or the accounts slip into the red? We still respond as if something has changed and set up teams to put things right when nothing has actually changed in the first place.

A final point to note is that we don't always require people to tamper; the sheet thickness example is a perfect example of where an automated feedback control system creates more problems than it solves in terms of process variability.

14.2.11. Selecting Subgroup Size

A compromise between time/cost to measure and sensitivity of control is the key element of this decision. The most common compromise is 5. Smaller subgroups are acceptable providing that the level of sensitivity is not compromised to too great an extent. If the control chart is sensitive enough to pick up most signals then there is no need to increase the subgroup size. See also comments on rational subgrouping which underpin any comments made here.

14.2.12. Selecting Sampling Regimes

This is very process dependent. You should take into account the rate of change of the process (is it stable like press tools or fast-changing like some machining processes). The faster the process changes the more frequent should be the sampling, this must be balanced against the additional effort required to take samples. Another factor is the number/value of items produced between samples as this is the quantity at risk (and which needs to be inspected if an 'out of control' signal is given). A common compromise is one sample per hour. Always err on the side of too frequent sampling in the early stages and relax this as control is demonstrated by long periods of stability. An important point to note here is that in SPC we deal with random rational subgroups this means that subgroups must be randomly selected from the population and the samples forming the subgroups must be consecutively produced. If our sampling pattern is too regular we run the risk of adversely affecting the randomness of our samples (by aligning with an unknown cyclical factor such as tea breaks etc.).

Always ensure that sampling plans and data collection plans in general are properly documented so that they can be repeated consistently if required.

14.2.13. When to Calculate Control Limits

Control limits are calculated using subgroup data and it is conventional to wait until 20 subgroups have been generated before performing the calculation. This can be done as soon as only 10 subgroups into the chart but the limits are somewhat questionable and should, in any case, be recalculated once 20 subgroups have been produced. It is also necessary to recalculate limits once a significant positive change in the process has been identified and cemented in by cause analysis or direct action. Do not recalculate limits as a result of negative changes to the process; find out why they happened and remove the cause to restore the process to its original equilibrium position. Whilst it is customary to redraw control limits once a chart has been physically completed this is not necessary and can be counter-productive in masking slow process change over time.

14.2.14 Individual and Moving Range Charts

A wide range of alternative charts are available for a number of different situations. Keller (2001) for example, has a comprehensive list. However, we shall only consider one, the ix/mR chart which, along with standard average and range charts will suffice for most situations.

In some circumstances a natural subgroup size of 1 suggests itself. Examples of this are monthly values (e.g. sales figures), periodic measurements from a continuous process or final test values for a series of complex products. In addition to this there may be cost implications to taking larger subgroup sizes, for example in the case of destructive testing. In such cases an individual and moving range chart is used. Within this chart we can see that the individual measurement corresponds to the average and the moving average to the range. The short term variability is estimated by the moving range which is the positive difference between the current individual plot point and the previous one. Exactly the same logic is applied to these charts as to the average and range, estimates of 3 sigma limits are applied to both charts. The calculations for IX/MR are shown below.

In many cases it may be appropriate to use an IX/MR chart to replace one of the attribute charts, since it does not assume any distribution and is thus more robust.

$$UCL_x = \bar{x} + \frac{MR}{d_2}$$

$$LCL_x = \bar{x} - \frac{MR}{d_2}$$

$$\frac{3}{d_2} = 2.660$$

$$UCL = 3.267\overline{MR}$$

14.3 Responding to Out of Control Conditions

Knowing how to spot an out of control signal is only half of the story. It is necessary to take appropriate action when a special cause is observed.

The first point to remember is that no out of control point should be ignored. The chart can be seen as the voice of the process. If the process says that something has changed you must always listen and look for the special cause of the situation. To ignore this warning is to run a process whose output you have no way of predicting. In the ideal case the process should be stopped until the cause has been found and eradicated. However, this is unlikely to be possible in every instance so it may be necessary to run with an unresolved special cause potentially present. In such a case it will be important to ensure that inspection-based controls are in place to protect the customer until stability has been regained. This is vital when the stable process has only marginal capability since the risk is greater that the impact of a special cause may push some parts produced by the process over the specification limits.

From A DMAIC project perspective there is no point in progressing to calculating process capability or DPMO for a process which is not stable. We must focus initially on gaining stability.

14.3.1 The Process Log

During a DMAIC improvement project the initial process control charts are an opportunity to learn about process, to make maximum benefit of this it is desirable to keep alongside (or preferably on) the chart a log of everything which happens which might have an impact on the variability of the process. This will obviously include such things as shift, operator, tool and batch changes but might also include observations about ambient temperature, passing traffic, tea breaks etc. In fact, the more detailed the better. As an example, it was found on one turning process that the opening of nearby external doors for the passage of factory traffic was sufficient in winter to reduce the local ambient temperature to such a degree as to have a significant effect on the process. Had this factor not been identified on the process log it is likely that this special cause would have gone unexplained for much longer. The first port of call, then, when an out of control point occurs should be the process log. In the majority of cases this will allow you to tie a special cause to an effect. When the control chart is being used to apply control to a process which is running the same principles apply.

14.3.2. Cause and Effect Diagrams

If the process log is not sufficient then a Cause and Effect Diagram (sometimes called Fishbone Diagram or Ishikawa Diagram) will need to be generated to establish what elements of the process (in its broadest sense) and the environment might have been responsible for the disruption. Normal problem solving disciplines will need to be applied to ensure that the right solution is arrived at.



360°
thinking.

Discover the truth at www.deloitte.ca/careers

Deloitte.
© Deloitte & Touche LLP and affiliated entities.

These activities will need to involve all process related local personnel and appropriate technical experts. Note that in the best organisations such activities are not merely reserved for the resolution of special causes but learning from and responding to the chart will be shared between the local team in regular informal meetings around the chart. In this way reduction of common as well as special causes can be undertaken even at the local level.

Cause and Effect Diagrams are certainly a useful way of organising the ideas generated at a brainstorming session. It is the most widely used, and probably one of the most useful of the “Seven Basic Tools” (Ishikawa, 1989). For example, we might begin by asking the question “Why are customers dissatisfied?” the answer may be “Because of dispersion (variation) in the product’s performance.” Product performance variation then becomes the quality characteristic and is drawn as such (see Figure 14.11). The next question to ask is “What causes product performance variation?” This may raise several answers such as: “Variation in the assembly process”, “Variation in the parts for assembly”, and so on. Each of these would then become a cause “branch” on the diagram. Each branch would then be separately investigated using questions like: “What causes variation in parts for assembly?” This may be answered by statements such as: “Machining Process variation.” “Raw material variation.” etc. Each of these would then become a “twig” on the “branch” of “Variation in parts for assembly”. This process would go on until the root causes of the variation in this branch were identified and then another branch would be tackled. This is sometimes referred to as ‘The Five Whys’, although the number of times you ask ‘why?’ is not fixed but continues until you reach a root cause.

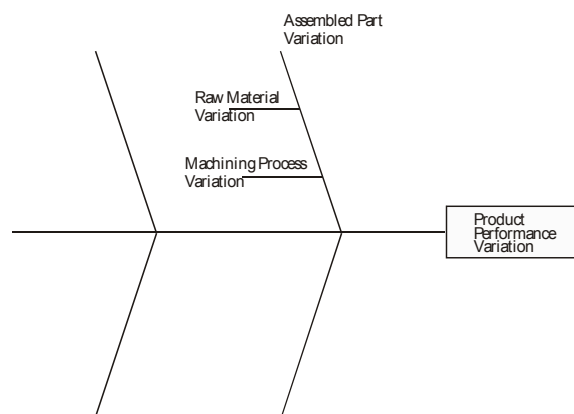

Figure 14.11. Cause and Effect Diagram for variation

Clarify the Issue for the Team: Explain the problem/issue to be considered and agree with the team a common understanding.

Brainstorm Key Causes: Apply the following rules: Ideas should be generated strictly in turn to avoid any individuals dominating proceedings. Passing on one’s turn is allowed. No criticism of ideas is allowed during the generation phase. All ideas must be recorded. No one person may dominate the discussion phase. The facilitator needs to ensure that the session remains focused on swift idea generation and does not degenerate into chat.

Agree Categories and Fit Brainstorm to Diagram: Individual to fit the requirements under the agreed categories.

Review the Diagram: Team to check that the diagram represents their collective understanding.

Prioritise Likely Causes: The team should look to establish which causes are most likely to influence the effect. A usual technique for achieving this is to give each team member 3 votes and look first at those causes garnering the most votes.

Collect Data: Plan and collect data to confirm the likely key causes identified in the last step and use this as a basis for further actions.

Detail is the key, here, generate as much data as possible and use the '5 whys' to get to the root causes. Empty or sparsely populated categories indicate a need for more thought in those areas.

This type of analysis can become somewhat complex if the starting point is taken at too high a level. This type of diagram is also rather sensitive to the knowledge of the individuals creating it, and sometimes minor causes are not isolated or observed.

14.3.2 Pareto Diagrams

If no obvious winners arise from the Cause and Effect Diagram it will be necessary to gather data to establish the key causes of variation. There are a number of tools and techniques available to address this, including scatter plots, hypothesis testing, designed experiments etc. However, one of the simplest and most useful in detecting special causes is the Pareto Diagram. The "Pareto Principle" manifests itself in industry in several forms, but the most important of these in practical terms is in the area of problems and causes. The principle effectively states that 80% of problems will be due to 20% of causes. The exact figures will vary; it may be 90% due to 30%, however, the general principle of "The important few and the trivial many" holds good. Thus, as a tool, it allows us to decide upon the most important areas for improvement on an analytical basis rather than relying on 'gut feel' or less rigorous methods. It is important to establish what the key criterion for analysis is. If it is time, for example, this should go on the y axis or money likewise. This ensures that the pareto you construct will answer the question accurately.

When collecting the data for a Pareto diagram ensure that data records are classified to enable the construction of a Pareto diagram. Ascertain the classifications to be used. Decide the time period relating to the graph. This should be a convenient period where possible (e.g. an hour, a shift, a week). The period should always be kept constant to allow for comparisons when dealing with the issue concerned. Construct the Diagram as follows:

- Total the frequency of occurrence of each category for the period.
- Establish the appropriate units (e.g. number of defectives, cost, etc.) for the vertical axis draw the axes and demark the vertical axis as necessary. Take care to ensure that the graph is easy to read. Label the vertical axis.
- Draw in the bars, beginning with the most frequent defective items on the far left. The height of the bar will correspond to the value on the vertical axis. Bars must be the same width. A category such as "others" may be used to denote several categories with limited frequencies and should be placed on the right hand side.
- Label each of the bars under the horizontal axis.
- Plot a line showing the cumulative total reached with the addition of each category. It is conventional for this line to be plotted in line with the top right hand corner of each bar.

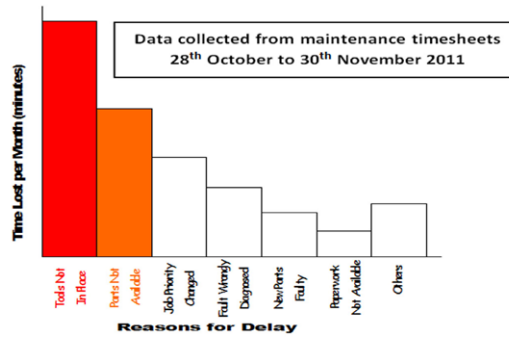



Figure 14.12. Pareto Diagram for special causes of delay in a maintenance activity

Clearly, in the example above the key issues are ‘tools not in place’ and ‘parts not available’. These would now form the focus for the DMAIC project team to stabilise the process. Clearly if there were other issues lower down the Pareto which could be easily and cheaply resolved these would be tackled too.

A Pareto taken over a short time period will tend to show mostly sporadic issues and one taken over a longer time (months) will tend to show more chronic causes. Redrawing a Pareto is useful to establish whether actions taken have been successful. If so, the overall level of cost should have fallen and those areas specifically tackled should have dropped down the Pareto.

SIMPLY CLEVER
ŠKODA 

We will turn your CV into an opportunity of a lifetime



Do you like cars? Would you like to be a part of a successful brand?
We will appreciate and reward both your enthusiasm and talent.
Send us your CV. You will be surprised where it can take you.

Send us your CV on
www.employerforlife.com



14.3.3 Improvement not Adjustment

Do not content yourself with tweaking the process when an out of control condition occurs. The point of SPC is to **improve not adjust**. There are, of course, occasions when adjustment is the correct short-term response, but consideration should be given to how to make the adjustment unnecessary -or less frequent- in the future.

14.4 Process Capability

Having achieved stability (or statistical control) in a process we can move on to the improvement phase of Juran's Trilogy. The start point to this phase is to compare the pattern of variation in a process to the acceptable limits (often tolerance or specification limits). This way we can understand if the equilibrium position we have reached by bringing the process into control meets the minimum company requirements.

14.4.1 Process Capability Calculations

Process capability in general terms can be seen graphically in section 7.2. If we wish to be more scientific about it we can actually calculate to what extent the voice of the process (as defined by the control charts) aligns with the voice of the customer (as defined by the specification limits). The first calculation we need to make is the process potential. This is denoted C_p . This essentially compares the process spread to the width of the tolerances. If the tolerances are wider than the process spread then, potentially at least, the process can achieve what is being asked of it.

$$C_p = \frac{UTL - LTL}{6\sigma}$$

It is clear that this measure however is not the whole of the picture. This measure would not, for example distinguish between processes B and C in the example as they have the same spread and C_p takes no account of setting. A better measure is one which takes account of setting and establishes the likelihood of producing non-conforming product for the process. This measure is shown above as C_{pk} . The two measures individually compare the distance from the process centre to either tolerance against the distance from the process centre to the top or bottom of the process (half the process spread in either case). Each of these tests basically ensure that the process will not overlap either limit. Clearly you could maximise one whilst minimising the other so we take the worst case in order to establish the overall C_{pk} .

$$C_{pk} = \frac{UTL - \bar{x}}{3\sigma}$$

OR

$$C_{pk} = \frac{\bar{x} - LTL}{3\sigma}$$

Whichever is Lower

Things to note about C_{pk} , include the fact that it's best achievable value is to equal C_p . This will occur when the centre of the process is equidistant from the two limits (i.e. the process is exactly on target). It is not possible for C_{pk} to exceed C_p . It is perfectly possible for C_{pk} to take a negative value if the centre of the process is outside one of the tolerances. This would represent over 50% non-conforming product but is not unknown.

14.4.2 Interpreting Process Capability Indices

Firstly it is necessary to state that the aim should always be for $C_p = C_{pk}$. This is analogous to saying that the process should always be set on target. This conforms to Taguchi's definition of 'Quality' as 'on target, minimum variation.' The aim for the values for C_p and C_{pk} is always the bigger the better. A value of 1 indicates that the process is operating at a minimum level of capability (i.e. at least one end of the process is bang up against a tolerance). Less than 1 means an incapable process. By using the properties of the normal distribution it is possible to predict percentages out of tolerance for any given capability value provided that the process is:

- Stable
- Normally distributed (approximately)
- Properly centred ($C_p = C_{pk}$)

The approach to improving process capability is essentially about reducing common cause variation. This will mean action on the process which is fundamental and probably management responsibility, relating to things such as operator training, machine maintenance, fixturing etc. The effect of such actions can be seen below:

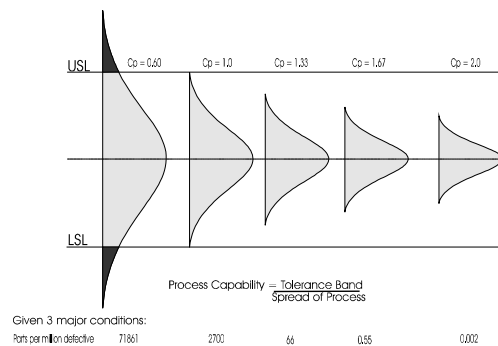

Figure 14.12. Improving process capability

It can sometimes be confusing trying to explain the meaning of capability indices. This might be best avoided and discussions centred on actual or expected levels of defective product for accessibility. Similarly, for improvement purposes C_p plus a statement of process offset from the target might be more helpful for process improvement than a C_{pk} figure. This is because the actions which affect spread and those that affect centring are usually very different and this notation separates the two. C_{pk} is a figure which may be used for high-level tracking of overall process 'goodness' but, due to its composite nature it is less helpful in showing what has to change. Finally it is possible to calculate the percentage of tolerance consumed by inverting the C_p figure and multiplying by 100%. Thus a C_p of 1.33 takes up 75% of tolerance and a C_p of 2.0 takes up only 50% of tolerance.

14.4.4 Establishing Process Capability Values

There are several ways of gaining the data for such calculations. The most robust is to estimate the process variability from an established control chart. This mechanism ensures that we have checked for stability in the data before establishing capability.

σ_{est} = Average range for chart/ d_2

σ_{est} = estimated standard deviation

d_2 = proportionality constant based on subgroup size

n	d_2	n	d_2	n	d_2
2	1.13	5	2.33	8	2.85
3	1.69	6	2.53	9	2.97
4	2.06	7	2.70	10	3.08

Table 14.4. Constants of proportionality (process capability from a control chart)

There are other ways of establishing standard deviations from the sample, but this is the most effective.

The calculations for process capability arose from a need to understand whether process output was likely to meet design intent. This can only be calculated with confidence for a stable process. There are various indices which give numerical interpretations of diagrammatic information. For conceptual understanding the diagrams are more useful than these summary statistics. Always try to communicate process capability information in the most accessible and useful way for the target audience. Process fallout tables assume normality. Other calculations start from an assumption of normality but are robust enough to work without it based on the pragmatic rules discussed in the introductory sessions.

I joined MITAS because
I wanted **real responsibility**

The Graduate Programme
for Engineers and Geoscientists
www.discovermitas.com



Month 16
I was a construction supervisor in the North Sea advising and helping foremen solve problems

Real work
International opportunities
Three work placements





14.5 Responding to Incapable Processes

14.5.1 Introduction

When a process is stable but incapable we need to understand the common causes of variation in the process in order to decide what action to take to improve the overall variation. The approach and simple tools discussed earlier will be sufficient in many cases to achieve acceptable levels of improvement. If this is not the case, or we wish to have a more robust answer, there are several more sophisticated approaches we can take:

1. **Establish whether the process distribution is different under different conditions:** This can be done using tools such as Hypothesis testing, ANOVA or Non-Parametric tests.
2. **Understand whether variation in a dependent variable can be explained by variation in another variable:** This is usually done by means of scatter diagrams, correlation plots and regression analysis.
3. **Test a variety of conditions to establish which factors contribute significantly to variation:** This is the area of designed experiments.

Points 1 and 2 are not covered in any detail in this text as they are well covered in “Essentials of Statistics” also available on Bookboon.com. Experimentation is an essential part of common cause variability reduction in many Six Sigma DMAIC projects and a broad indication of the approach, for more detail try Yang and El-Haik (2003).

14.5.2 Design of Experiments

An experimental design sets out to investigate whether a series of factors, when varied have an effect on the variable of interest (usually referred to as the ‘Response Variable’ or ‘Quality Characteristic’). It is a more structured way of approaching the kind of ad hoc experimentation which goes on in a lot of organizations. All experimentation follows the same basic approach:

1. **Define the Experimental Goals:** We need to clarify what we are looking to achieve from the experiment and the scope of the investigation.
2. **Select Response Variable (Quality Characteristic):** This will usually be the key performance measure of the process; the thing we are interested in optimising; the ‘Critical Y’ in Six Sigma terminology.
3. **Choose factors, levels and ranges:** Brainstorm/Cause and Effect analysis can establish potential factors which may affect the Quality Characteristic. Factors can be continuous (e.g. how much milk we add to our tea) or discrete (e.g. do we add the milk before or after the tea). We will need to change each factor at least once to observe the difference it makes. Accordingly we shall select 2 (or more) levels for the factor, ensuring that the range is sufficient to have an effect, but not so large as to move outside reasonable ranges.
4. **Select Experimental design:** Given the question you wish to answer, the number of factors and levels and resources required we can select an appropriate experimental regime.
5. **Perform the Experiment:** Ensuring that experimental error is kept to a minimum.
6. **Analyse the outcomes:** Using appropriate techniques for the design chosen.
7. **Draw conclusions and make recommendations:** Taking care to test the recommendations to ensure that the experiment has not been compromised in a way which we did not spot.

There are a number of approaches to experimental design, and it is not my intention to compare them in this text.

14.6 Evaluating the Measurement System

Although most people don't recognise it measurement is a process too. As such, it is subject to both common and special causes of variation. If we recognise this it has to have an implication for the application of process control charts. Dr. Shewhart recognised this and commented on the fact back in 1931.

'In any program of control we must start with observed data; yet data may be either good, bad, or indifferent. Of what value is the theory of control if the observed data going into that theory are bad?'

Shewhart (1980)

The variability in measurement systems can lead to inappropriate decisions and actions (Keller, 2001).

- Acceptable products or service outcomes could be measured as unacceptable and rejected.
- Products or service outcomes which are unacceptable could be measured as acceptable.
- Controlled processes could be diagnosed as out of control and effort wasted.
- Uncontrolled processes could be diagnosed as in control and special causes and associated opportunities for learning missed.

If we are to avoid such mistakes we have to be able to characterise the variability in our measurement process and ensure that it is not interfering with the data to a significant effect.

14.2.1 Types of Measurement Error

There are essentially 4 types of variation which can affect how closely measured data reflect the true reading. These are characterised by the diagram below.

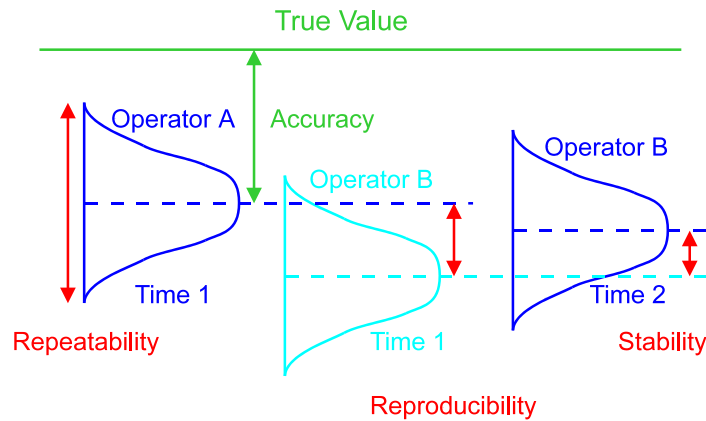

Figure 14.13. Types of measurement error

Accuracy is the difference between the average measurement produced by the process and the true value of the data measured. This is assessed using a standard measured item, repeatedly measuring it, taking the average and comparing it to the true value. This can be thought of as a bias.

Repeatability is the variation within a set of measurements taken on a single piece part. This can be assessed as above except that it is the dispersion rather than the average which is calculated. This is essentially a measurement of the common cause variation within a process when it is used by just one operator.

ie business school

#1 EUROPEAN BUSINESS SCHOOL
FINANCIAL TIMES 2013

#gobeyond

MASTER IN MANAGEMENT

Because achieving your dreams is your greatest challenge. IE Business School's Master in Management taught in English, Spanish or bilingually, trains young high performance professionals at the beginning of their career through an innovative and stimulating program that will help them reach their full potential.

- Choose your area of specialization.
- Customize your master through the different options offered.
- Global Immersion Weeks in locations such as London, Silicon Valley or Shanghai.

Because you change, we change with you.

www.ie.edu/master-management | mim.admissions@ie.edu | f t in YouTube

Reproducibility is the difference between the distributions for the same measurement process, measuring the same item when used by different operators. It should be noted that this is not relevant only where the process is not operator dependent in its operation or set-up. It is important to understand the differences between the distributions in terms of both variability and average. The mechanism for testing this is for the operators to measure part a number of times.

Stability is the 'drift' of the measurement process over time. This would be assessed by measuring the part measured earlier at a later date and comparing the distributions for average and variability.

All the four types of error need to be considered for each process. The amount of variability generated by repeatability and reproducibility must be assessed and compared to acceptable levels. Action to reduce this variability will need to be taken if it is at an unacceptable level (such action is desirable, even if it is at an acceptable level). Accuracy can be dealt with by use of a correction factor. Stability is best dealt with by process design and by setting maintenance/calibration intervals to stop the drift before it becomes significant.

14.2.2 Sources of Measurement Error

If an effective approach is to be taken to measurement variability it will need to involve an understanding not just of the amount of variability introduced by the measurement process but where it is coming from. The diagram below gives some indications of potential areas of variability in a typical measurement system.

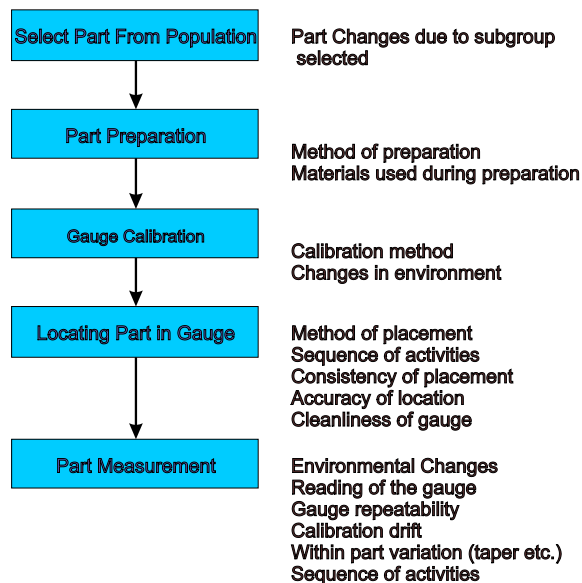

These are exacerbated if more than one operator is involved.

Figure 14.14. Sources of measurement error

It would be good practice to derive a similar diagram which relates to your measurement process. In a similar way to other business processes this allows you to know where to look for reductions in variability.

14.2.3 The Measurement Assessment Process

Note that this is only one possible option for assessing variability within the measurement process. There are many different systems. Look for the logic applied in any system which you might choose to use. The steps of this process are outlined below:

1. **Define the system to be studied.** This will mean flowcharting the process, identifying potential or actual operators and the parts under consideration.
2. **Identify 3 or more operators** (if there will be more than one operator using the system).
3. **Identify and label 10 or more parts.** This is effectively subgrouping the data.
4. **Each operator measures each part several (5 recommended) times.** Ensure that measurements are done blind and in random order, so that the operator does not know which part they are measuring to avoid accidental (or deliberate) biasing of data. This is another good reason for not simply using one part. Make sure that appropriate zeroing/calibration procedures are followed.
5. **Whilst measurement is in progress observe the process and note any causes of variation which are apparent.**
6. **Record measurements on the gauge R&R sheet.** It is useful at this stage to track the variability over time on a run chart to ensure that there has not been any drift in measurement over the course of the study.
7. **Generate Average and Range charts:** Plot the average for each part measured by each operator (so operator A, part 1 average would be the first point, operator A, part 2 average would be the second point and so on. In effect R is the test-retest error (or repeatability). Look for the R chart to be in control (stable test-retest error) and the Average chart to be as far out of control as possible. If it is in control the test-retest error is obscuring the product variation, meaning the measurement system cannot tell the difference between parts.
8. **Construct Bias Chart:** Group all data by operator. Construct a control chart for the average measurement by operator. Apply normal control chart rules; if all averages are in control there is no bias present in the measurement system.
9. **Construct Inconsistency Chart:** Group all data by operator. Construct a control chart for the range measurement by operator. Apply normal control chart rules; if all ranges are in control there is no inconsistency present in the measurement system – i.e. all operators are similarly variable.
10. **Calculate Discrimination Ratio .** Calculates how many distinct classes are visible by a measuring system.

$$\text{No. of classes} = \sqrt{2} \left[\frac{PV}{R\&R} \right]$$

PV = Product Variation

R&R = Gauge repeatability and reproducibility estimates.

A discrimination ratio of 4 or higher is deemed acceptable (Wheeler and Lyday, 1990)

14.2.3 Interpreting Measurement Studies

If repeatability is different between operators the process inherently lacks reproducibility. Address common causes of variability observed to differ between operators. You will need to ensure that only the best operator is used until the differences in variability have been resolved.

If the repeatability is consistent but unacceptable the process lacks repeatability. Address common causes of variability within the process.

If the offset between operators is significant this indicates a lack of repeatability. Address special causes of variability between operators which could relate to mean shifts.

14.7 Summary

This section takes the reader through the DMAIC process from a variability perspective. This is the heart of Six Sigma, reducing variation is the engine which drives business benefit and customer satisfaction.



"I studied English for 16 years but...
...I finally learned to speak it in just six lessons"
Jane, Chinese architect

ENGLISH OUT THERE

Click to hear me talking before and after my unique course download



Review & Discussion Questions:

- 1. Why is it important to understand control before calculating capability?*
- 2. How might we best address the need to feedback into planning from improvement within Juran's Trilogy?*
- 3. Measure the time it takes you to get to school/work over the course of 4 weeks. Create a control chart. Consider also measurement error. Is your process stable? Capable? Are you over-engineering (allowing way too much time for your journey?) Can you experiment to see what is controlling your journey time?*

15 Soft Aspects of DMAIC

15.1 Learning in and Between Projects

Six Sigma is demonstrably a learning process (Guieerrez et al, 2011). However, the need to create both an effective learning process and environment is still significant) and lies principally in the hands of the Black Belt and Champion for the project. Working in teams and the structured process management approach (DMAIC) have both been shown to affect absorptive capacity, and through that organizational learning (Guieerrez et al, 2011).

15.1.1 Creating a Learning Environment

Develop dialogue within the team:

An open environment is required to allow for genuine dialogue. Dialogue is about exploration and openness. Team members must feel free to challenge ideas and decisions and to express opinions. Team leaders need to utilise the knowledge and expertise available to them to develop a comprehensive understanding of a situation, and to do what Weick et al (2005) described as “sense-making”, which he described as a similar skill to cartography. The team leader draws upon the views of multiple informants to create a ‘map’ of the topic area. The map may not be the objective truth in a complex situation, but it represents the best combination of existing knowledge, and therefore the best basis for decision making. A leader making decisions might consider the following model of communication:

“This is how I see the situation. Does anyone see something I’ve missed, or have a different view?”

“Based on the understanding I have outlined, these are the options I can see. Does anyone see any other options?”

“These are the criteria I think are relevant (and their relative importance) to make the decision, and this is why. Does anyone disagree with these criteria, or feel there are any to add?”

“So this is my conclusion on what to do. Does that make sense? What have I missed?”

This encourages contributions and co-creation of strategies and often brings to the fore tacit knowledge which the holder was unaware might be significant.

Share Information:

There can be a tendency to see the Black Belt as the expert and the holder of knowledge, it is tempting to hold information until it is needed. The principle is to share as much as possible, as soon as possible. It is impossible to know how and when people will use information, and too little is far more of a problem than too much.

Create A Reflective Space:

Too often projects are driven by deadlines and outcomes. All discussion focuses on delivery and goals. This does not allow the team space (either individually or as a group) time to reflect on what has happened, and what it means. Valuable learning opportunities are lost. The Black Belt needs to create regular space for reflection and perhaps prompt it by the use of learning logs and discussions. Research shows strongly that writing something down increases your understanding, and that discussing it with someone else increases it still further.

Use Metrics and Goals Formatively:

Targets and milestones are often used in a judgemental way, with laggards being chastised and those who are on target praised. However, this kind of behaviour leads to dishonesty and game playing, thus starving the team of the opportunity to learn. Use missed targets and goals (as well as achieved ones) as an opportunity to learn. Encourage honesty and support open discussion of how to do better.

15.2 People in Improvement**15.2.1 Appreciative Inquiry**

When engaging with the local team where the DMAIC project is taking place it is important to create as much common cause as is possible. It is difficult to do this if the start point is a litany of the failings of the current process. Appreciative Inquiry (Whitney et al, 2010) starts from asking what works really well (there is always something that does) and getting the team to remember a time of high satisfaction and motivation. This creates a very positive energy and a good place from which to explore getting better. It builds towards excellence rather than away from failure.

15.2.2 Soft Systems Methodology (SSM)

Six Sigma is a 'Hard' improvement system, it has a somewhat mechanistic approach and is process driven. This has its strengths, but many (arguably all) problem situations have a very significant 'human' element; they are messy and pluralistic and there is no single view of the problem. In such circumstances a 'Hard' approach is likely to alienate those who see the problem differently and runs the risk of ailing to get to grips with the complexity of the issue and generating a naïve solution.

Excellent Economics and Business programmes at:



**university of
 groningen**



**“The perfect start
 of a successful,
 international career.”**

CLICK HERE
 to discover why both socially
 and academically the University
 of Groningen is one of the best
 places for a student to be

www.rug.nl/feb/education



SSM is designed to access the individual perspectives on the unstructured problem, and build understanding and options before designing an improvement.

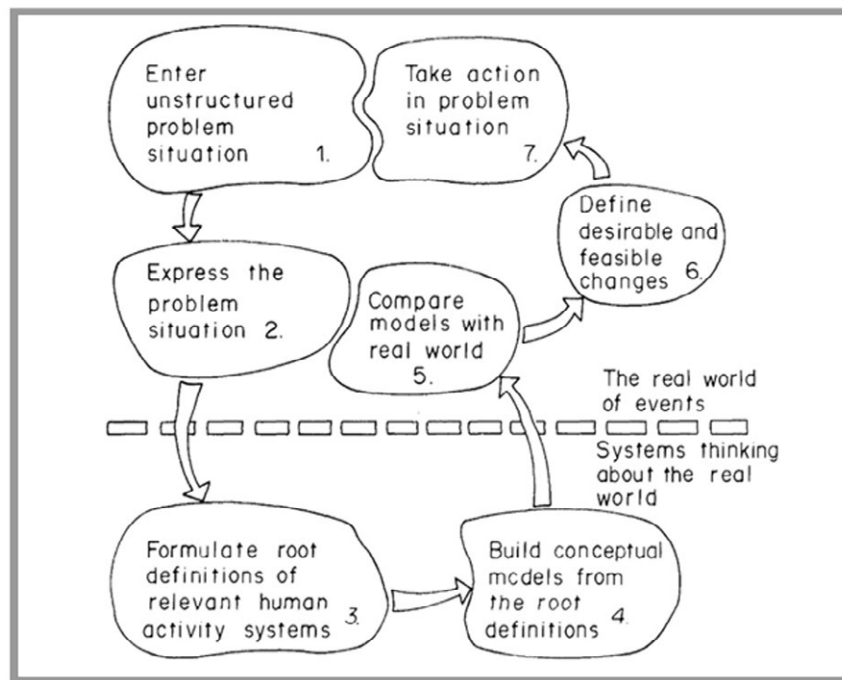

Figure 15.1. SSM Approach (Checkland, 1985)

The first two stages are about collecting the maximum number of impressions of the problem situation, or system. Participants draw rich pictures expressing the situation from their perspective. At this stage it is very important to avoid analysing the pictures and there is no attempt to define a definitive picture of the process, just ideas that could be useful in improvement.

The third stage is about developing purposeful activity models. A clear definition of the purposeful activity is necessary to be able to build a model out of it. These definitions are called 'root definitions' according to SSM (Checkland, 1999). The root definition is an expression for the transformation process (T) that turns an input to output that is different in form from the input. Transformation is better elaborated by other elements that form the mnemonic CATWOE. CATWOE is explained by Checkland (1985) as follows.

C 'Customers': the victims or beneficiaries of the transformation.

A 'Actors': Those who would do the transformation.

T 'Transformation Process': the conversion of input to output.

W 'Weltanschauung': the worldview which makes transformation meaningful in context.

O 'Owner/s': those who have the ability to stop the transformation.

E 'Environmental constraints': elements outside the system which it takes as given.

Checkland (1999) stresses that from experience, forming the root definition in the shape of “do P by Q in order to contribute to achieving R” adds more value when it is used in addition to considering CATOWE. Using PQR answers three questions: what to do (P)? how to do it (Q)? and why do it (R)?

The CATWOE has clearly some similarities to the SIPOC traditionally used in DMAIC processes, but it pays much more attention to softer aspects.

Building on the root definition the conceptual modelling process is designed to use real experience but to base the model on the root definitions.

The work then moves back into the real world to compare the conceptual models to reality and agreeing desirable and feasible changes which are then enacted and reviewed.

There is, of course, much more to say on SSM, but it should be clear that it brings other dimensions to improvement which are normally missing in Six Sigma. Aside from this, the process often builds more confidence and buy in from participants as their perspective and expertise are central to developments.

15.2.3 Change and Involvement

It is worth briefly reminding the reader of the need to be aware of the change and involvement issues raised at initiative level, as these are still relevant at the project level.

15.3 Summary

Six Sigma DMAIC projects are often conducted in a rather mechanistic way with an undue focus on tools and process. Of course these things are important, but if the softer aspects are not considered and appropriate approaches applied chances of success are compromised. Eckes (2001) amongst others notes that the majority of Six Sigma projects that fail will do so because of the human element.

Review & Discussion Questions:

- 1. Consider the standard Six Sigma DMAIC approach, how is this enhanced by taking into account softer aspects.*
- 2. Attempt to create a rich picture of the process of University education. Who are the actors? What are they concerned with? How do the various stakeholders view the process?*

16 Processes in DMAIC Projects

16.1 Introduction

The means by which all customer value is delivered is a process; hence Six Sigma's central treatment of the process. In the Define phase we need to understand what elements of the process delivers customer value, and exactly how the present process operates. Improvements will require changes to the process and one aspect of the Control phase will be the dissemination of new process maps and descriptions.

16.2 Supplier-Input-Process-Output-Customer (SIPOC) Diagram

The SIPOC diagram is designed to understand the process with a view to the value stream. It identifies the Suppliers to a process and what inputs they provide; the process itself; its customers and the outputs they receive. It further details the controls etc. to understand how well the process is focused on the inputs and outputs crucial to value. An example of a SIPOC Diagram can be seen in figure 13.2 in chapter 13.

16.3 Process Flow Chart

The purpose of a flow chart is to represent the process on which the team is working. Accordingly it needs to be constructed with the input of those personnel who are intimately connected with the process. It is very important to understand exactly what happens, as opposed to what is supposed to happen. The process for creating a flow chart is shown below:

American online

LIGS University

is currently enrolling in the
**Interactive Online BBA, MBA, MSc,
DBA and PhD programs:**

- ▶ enroll **by September 30th, 2014** and
- ▶ **save up to 16%** on the tuition!
- ▶ pay in 10 installments / 2 years
- ▶ Interactive **Online education**
- ▶ visit www.ligsuniversity.com to find out more!

Note: LIGS University is not accredited by any nationally recognized accrediting agency listed by the US Secretary of Education. More info [here](#).





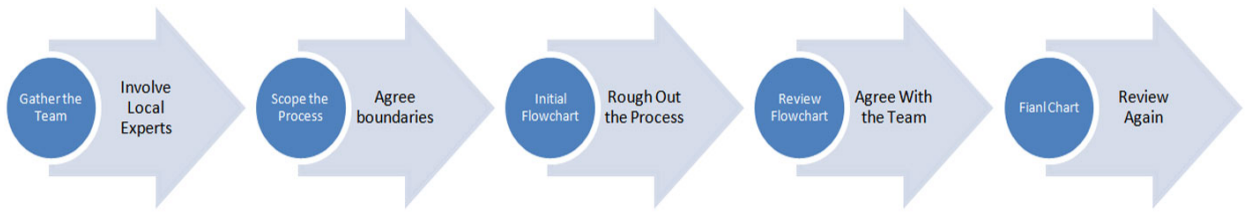

Figure 16.1. Primary, secondary and tertiary requirements (partial) for an aircraft seat.

This is an example of the simplest type of flowchart that can be used. In general it is recommended to keep the chart as simple as possible, but it may be helpful to use a deployment flowchart for example, which indicates which department is responsible for certain steps in the process. This can be extremely useful for understanding where handovers occur (often an area where problems are generated). More detailed flowcharts can indicate the different types of activities that are happening (inspections, areas of storage etc.) which helps to further refine the understanding of the process. The key is to convey the information accurately and in sufficient detail for the team to understand where issues may be arising.

16.4 Value Stream Mapping

Value Stream Maps (as the title suggests) focus on understanding the process as a value stream. They are used to see where value is added in the process and to identify non-value adding elements. It is not unusual for there to be less than 10% of the process steps which actually add value. This helps to focus on waste in the process and is a key part of Lean activities.

An example of a Value Stream Map (VSM) for a typical manufacturing process is shown in figure 16.2. It can be seen that the proportion of time spent adding value to the product is very low. This is a very typical discovery in VSM, and can help to focus on the activities which do not add value.

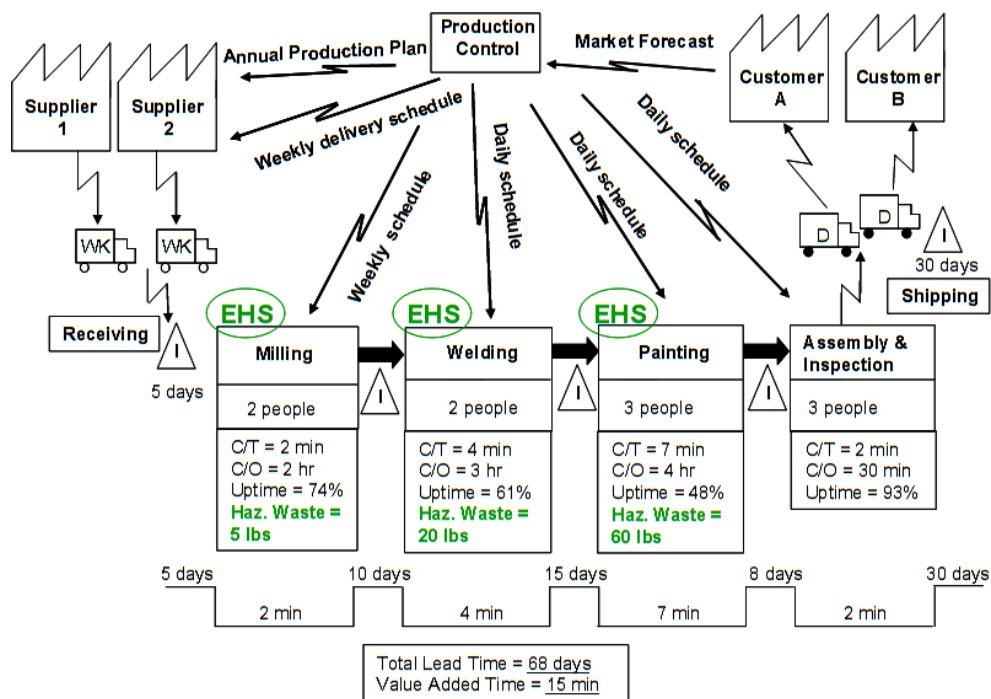

Figure 16.2. Example of a Value Stream Map (Wikipedia, 2011)

16.5 Soft Systems Methodology

SSM (see Chapter 15 for details) is not commonly used in Six Sigma projects but it has been suggested as a useful addition. It is different from the other approaches described in that it does not seek to establish some ideal 'true' picture of the process, but recognises that different individuals will see the process in different ways. The 'Rich Pictures' generated in the early stages of SSM are designed to create options for discussion rather than to be definitive and unchallenged. This approach is particularly useful in messy complex situations and takes into account the human element of processes which can be absent in the more mechanistic approaches.

16.6 Summary

Processes are the way in which outcomes are delivered. Six Sigma seeks to understand processes and modify them to create business benefit. Each individual project will use them in the way most suited for the problem under consideration, they may be idiosyncratic in some cases but must effectively communicate their message.

Review & Discussion Questions:

1. *Compare and contrast the various approaches to mapping processes described in this chapter: in what circumstances would you choose each one?*

17 DMAIC in Service Organizations

17.1 Introduction

Six Sigma was originally applied to manufacturing; however, it has long been expanding in what are described as ‘Transactional’ settings –service settings in lay language – with considerable success. Examples include reducing transfer times from an overcrowded emergency room to an inpatient bed which improved patient safety and delivered \$6000,000 dollars annual savings (Revere and Black, 2003); reduction of credit processing time by over 50% (Rucker, 2000); reduction of the number of delayed deliveries in a logistics organization saving an estimated \$400,000 (Thawani, 2004). Despite this there remains a widespread belief that Six Sigma is not relevant to service organizations.

17.2 Service is Different

The unique aspects of service from a Six Sigma perspective are readily apparent:

- The service is often created and delivered at the same time (a hotel receptionist, for example, creates and delivers the checking-in service at exactly the same time). This means that the option to ‘inspect quality in’ is very limited.
- Service inherently includes a human element.



.....Alcatel-Lucent 

www.alcatel-lucent.com/careers

What if you could build your future and create the future?

One generation's transformation is the next's status quo. In the near future, people may soon think it's strange that devices ever had to be "plugged in." To obtain that status, there needs to be "The Shift".



A study carried out by Antony et al (2007) suggests the following additional issues:

- Problems with accuracy and completeness of data.
- Often the customers hold the data and getting them to share it is difficult.
- The soft aspects of service make measurement and interpretation of satisfaction difficult.
- Processes are often unclear and mediated by the behaviours of staff and customers.
- DPMO measures are sometimes difficult to define.
- Human and organizational changes predominate over process changes.

17.3 The Dimensions of Service Quality



Figure 17.1. The Five Dimensions of Service Quality (Zeithaml, Parasuraman and Berry 2009)

The five elements create a holistic view of any service environment; firstly the tangible aspects of the environment must look right. Note that ‘right’ does not necessarily mean that it should be luxuriously appointed in all cases; a fast-food outlet needs primarily to look clean and efficient, whilst not implying to a customer that a lot of money has been spent on excessive luxury. A management consultant may, on the other hand, find it useful to wear designer clothes and drive a high end car – clients wish to know that they are hiring someone who is doing well at their job.

Secondly, the organization needs to ‘do what it says on the tin’ in terms of delivering customer promises and expectations. If the fast food is not fast, or not acceptable in terms of quality then the rest will not matter.

Thirdly, a responsive organization would attempt to customize the service for the customer, and respond effectively and quickly to any particular requirements. One might think of Burger King’s “You got it” adverts as stressing their flexibility and responsiveness. Similarly, a dental service which can fit in emergency patients quickly, or an insurance company which can quickly provide quotes on unusual risks or in unusual circumstances without a hefty penalty would be seen as responsive.

Fourthly, assurance would be the confidence inspired by the staff through their demeanour, dress and demonstrated knowledge. Concierge services at high end hotels would perhaps be the most obvious positive example of this, whilst wildly contrasting examples might be available in large computer shops where staff knowledge can often be rather lacking.

The final and most challenging piece of the jigsaw is empathy. Empathy is the ability to put yourself in the place of the customer. An empathetic service make the customer genuinely feel at the centre of the service and cared for. A car salesperson, for example, might improve the customer experience (and long term performance) by recognising and responding to customer preferences, rather than attempting to ‘up sell’ and get them to buy the most expensive car and options that they can be persuaded to. Empathy is often a nebulous concept, but customers know when they have experienced it, and will seek it out over and over again.

17.3 Contribution of Six Sigma

Given the above measures, traditional Six Sigma clearly has a more limited role to play here. Tangibles and reliability would be the elements where Six Sigma might be able to help with things like error and waste reduction and increased speed, as shown by the examples earlier in the chapter. The other dimensions would need to be addressed in other ways (See “Quality Management in the 21st Century” at Bookboon.com for further details).

Most Commonly Used Tools & Techniques	Least Commonly Used Tools & Techniques
Process Mapping	Kano Model
Brainstorming	Statistical Process Control
Root Cause Analysis	Quality Function Deployment
Run Charts	Design of Experiments
Benchmarking	Process Capability analysis
Pareto Analysis	Poka-Yoke
Change Management Tools	Gap Model (Service Quality)

Table 19.1. Application of Tools and Techniques in service sector (Antony et al, 2007).

Six Sigma is still relevant in service organizations, but may not be sufficient. Interestingly, it would seem that even when applied the DMAIC process in service organizations uses different tools; unsurprisingly perhaps, the simpler less mathematical tools are preferred with numerical and more complicated techniques used much less frequently as shown in table 19.1.

Even though the tools used vary enormously the critical success factors for Six Sigma in service environments correlate strongly with those in manufacturing (Antony et al, 2007). This perhaps reinforces the idea that the most important parts of Six Sigma are not the tools but the softer elements.

17.4 Potential Modifications to Six Sigma in Service Environments

As can be seen, traditional Six Sigma is not a perfect fit in terms of tools for service environments. Accordingly, some additions or modifications might be suggested:

- **Lean Six Sigma:** This approach embodies Lean tools (such as Value Stream Mapping, 5S, Waste Analysis, etc.) within the DMAIC cycle. In many cases these tools are better suited to address the issues in service companies.
- **Design for Six Sigma:** While the more technical tools do not fit here, when processes are undefined in many service operations it makes sense to use the DFSS approach to develop a process from scratch.

- **Soft Systems Methodology:** As an approach which is sensitive to emotions and varying perspectives, SSM may offer better approaches to modelling service environments than the hard systems view of traditional Six sigma tools like SIPOC.

17.5 Summary

The perception of the differences between service and manufacturing applications may be exaggerated – for example in table 17.1, they happily use run charts but say that SPC cannot be used when both of these use exactly the same data – but perceptions are important. There are opportunities to modify the approach to make it more service-friendly, or to focus on the elements where the relevance is clearer.

Review & Discussion Questions:

1. *How are Six Sigma projects in service organizations different to those in manufacturing?*
2. *What might need to be added to traditional Six Sigma projects to address the aspects of service not usually covered in the traditional approach.*

Maastricht University *Leading in Learning!*

Join the best at the Maastricht University School of Business and Economics!

Top master's programmes

- 33rd place Financial Times worldwide ranking: MSc International Business
- 1st place: MSc International Business
- 1st place: MSc Financial Economics
- 2nd place: MSc Management of Learning
- 2nd place: MSc Economics
- 2nd place: MSc Econometrics and Operations Research
- 2nd place: MSc Global Supply Chain Management and Change

Sources: Keuzegids Master ranking 2013; Elsevier 'Beste Studies' ranking 2012; Financial Times Global Masters in Management ranking 2012

**Visit us and find out why we are the best!
Master's Open Day: 22 February 2014**

Maastricht University is the best specialist university in the Netherlands (Elsevier)

www.mastersopenday.nl



18 Successful DMAIC Projects

Six Sigma project success factors have essentially been covered in previous chapters in some depth, the list below summarises the key ones:

- Selection of appropriate projects (linked to strategy, potential for significant benefit, motivating to team and sponsors).
- Black Belt and Champion skills (technical, leadership and project management).
- Involvement and participation of local experts.
- Appropriate application of the correct tools. Remembering that it is important not to use tools just because you have them (Goh, 2010) – use the simplest appropriate toolset for the problem in hand.
- Environmental issues (senior management support, availability of data, etc.).

19 Example of a Six Sigma Project

19.1 Introduction

This paper looks at a successful application of the Six Sigma improvement methodology within a major sweet manufacturer in Europe. This site produces 180,000 tons of confectionary per annum and is part of a global organization, which employs some 30,000 people world-wide with gross sales of \$13 billion per annum.

Changes in the confectionery market in have pushed the business to increase the focus on cost effectiveness, with European business units being measured with a variety of performance indicators, including the factory gate cost, this business faces a challenge to reduce the cost of its products to bring them in line with the cost of similar products made at other European factories. It has to do this with a workforce that has not faced this challenge before and with an infrastructure that has evolved to enable growth, sometimes at the expense of efficiency.

The wider organization had not embraced Six Sigma prior to the conduct of this project, although this site was keen to use Six Sigma to tackle its key business challenges. The aims were to generate financial benefits while also increasing awareness of variability as an issue for the organization and enhancing the ability of employees to improve the processes with which they work.

19.2 Project Background

Product is X one of two medicated brands produced at the plant, which is the sole producer of Product X for the UK market, with an output of 1.4 million packs per week, with sales only limited by production capacity.

The Product X manufacturing facility has historically suffered from three principal problems:

1. Inability to meet production schedules.
2. High rework rates and scrap
3. Machine downtime

This project was set up to find a way of tackling these issues.

19.3 Selection of a Quality Characteristic

The project was defined as strategic since the area was facing imminent off-shoring with the plant strategy being to keep as many products in-house as possible. As a demonstrator project it also fit with the strategic intent to develop an internal capability in problem solving and process improvement and to develop a more systematic understanding of the process.

The team selection had the author as the responsible Black Belt as no appropriate expertise existed within the organization. Team members were selected from the local area due to their motivation levels and process knowledge. A blend of expertise was also important, so one food technologist with a specialist knowledge of the chemistry of the product was selected as well as 2 operators for practical process knowledge (and as opinion formers on the shop floor) and two production engineers for a more technical understanding of the processes.

Product X is a type of sweet designed to relieve symptoms of the common cold. An automated process, consisting of cooking, forming and wrapping lines, starting with raw syrup solution and ending with fully packaged sweets, produces the product. As the product is made from a recipe with a high sugar/solids ratio, it tends to be hygroscopic, an effect that causes the sweets to deteriorate if stored unprotected in normal atmospheric conditions. To preserve the product, Product X are kept in a special low humidity atmosphere and are prepared for sale by wrapping them first individually in wax paper, and then into a foil stick pack, e.g. of eleven sweets.

All Product X are wrapped using specialist high-speed wrapping machines. These machines can wrap 950 individual sweets per minute. For the wrapping quality to be good at these speeds, the sweets must be consistent in size and shape. If they are not, wrapping performance is slow, product quality is low and machine reliability is poor. Due to the way that the sweets are handled in the machines and accumulated into a pack, the critical characteristic linked to good wrapping performance is sweet thickness. The acceptable thickness range is between 8.0mm and 8.4 mm with a target of 8.2mm, if the sweets are too thin, the machine drops the sweets from the gripper jaws and if they are too thick, the sweets are crushed by the jaws, or in extreme cases, the pack of eleven sweets is too long and the pack itself is damaged. Broken or dropped sweets and jammed packs build up in the machine and cause wear on the moving parts and machine downtime to clear the debris.

Sweet thickness was chosen as the key quality characteristic as it clearly drove the three major losses noted in the last section. Presently sweet size is a secondary check using a GO / NOGO gauge, with primary focus being on pack weight which is the regulated aspect of the product.



> Apply now

REDEFINE YOUR FUTURE
**AXA GLOBAL GRADUATE
PROGRAM 2015**

redefining / standards 

agence eds - © Photonistop

19.4 Methodology

The DMAIC cycle was used as shown in figure 19.1.

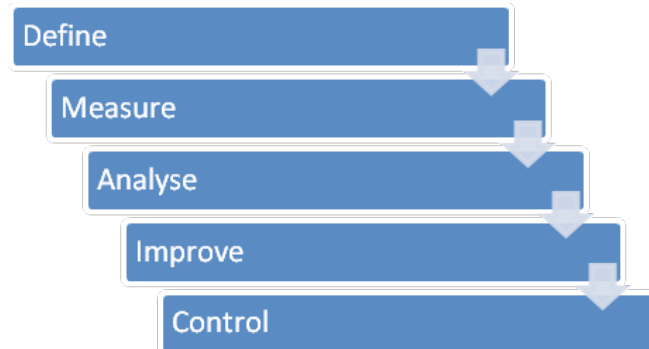

Figure 19.1. DMAIC Process

19.4.1 Define the Opportunity

Figure 19.2 shows the Reverse Cause and Effect diagram generated by the team to establish the likely effects of sweet size variation on the process.

Overall, the cost of sweet size variation can be seen in reduced wrapping speeds, high maintenance costs, high scrap, low product quality, high energy usage, high labour usage and poor motivation. The team now attempted to put a monetary value on these issues. Where no direct cost could be identified a decision was taken to ignore that element of cost to avoid over-estimating the potential for improvement.

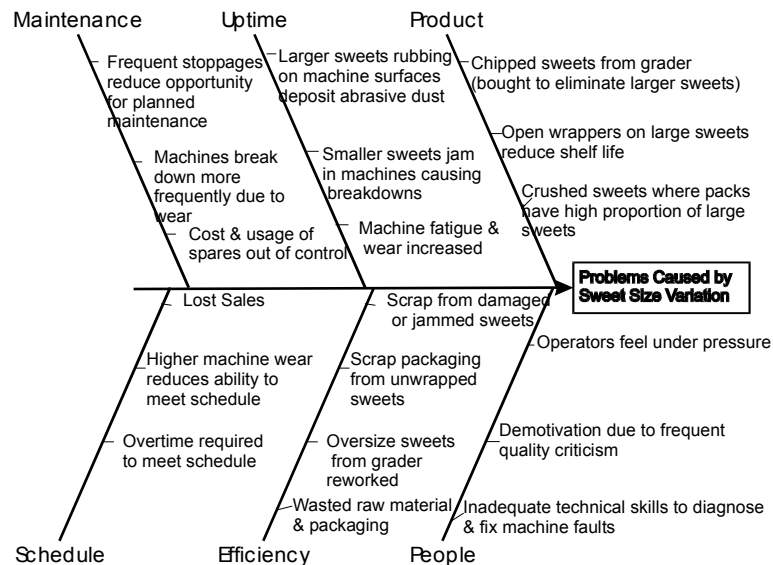

Figure 19.2. Reverse cause and effect diagram for the effects of sweet size variation

Table 19.1 summarises the costs, which totalled £455,000 per annum.

Description of Loss	Method of Quantification	Per Annum Cost
Sweets scrapped resulting in excess raw material usage	Number multiplied by cost per sweet of raw material and processing	£360,000
Additional maintenance costs due to rapid wear caused by abrasive sugar dust from broken sweets.	Comparison with levels of maintenance on wrapping machines where sweet breakage due to size was not a problem.	£45,000 (estimate)
Additional labour costs to cover machine downtime	As Above	£50,000 (estimate)

Table 19.1. Readily quantifiable costs of sweet size variability

19.4.2 Define the Process

The Team mapped the process using the affinity approach, with all of the team members being allowed to generate their version of events. The team then discussed and refined the ideas to form one process that was agreed by all. The agreed process flow chart is shown in figure 19.3 and formed the basis of all future discussions.

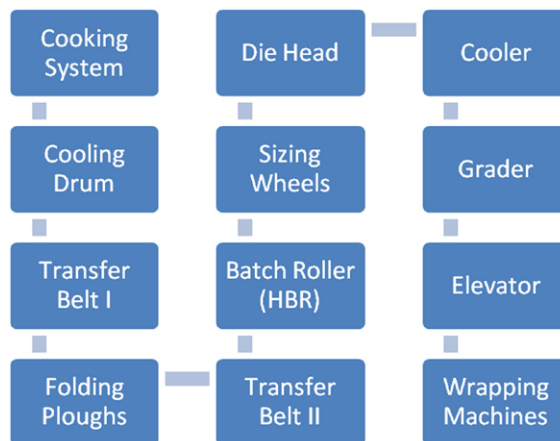



Figure 19.3. Agreed process flow chart

The sweets are made on a cooking, forming and cooling process before being wrapped. At the cooking stage, a sucrose and glucose syrup mixture is continuously heated until a very low percentage of water remains. At a temperature of around 145 °C, the syrup is layered onto a rotating cooling drum, which cools the syrup into a continuous ribbon of soft toffee. This ribbon then falls from the drum to a transfer belt, where it is folded using fixed ploughs, which turn the ribbon inwards, reducing the width and increasing the thickness. This helps the toffee retain some of the heat and therefore the malleability characteristics for forming. The ribbon enters the horizontal batch rollers, where it is rolled and compressed into a conical mass, the rollers reduce the mass down to a 30 mm diameter 'rope' at the outlet end, which then enters a set of five sizing wheels. These wheels further reduce the diameter of the rope and control the flow rate into the die-forming head. This head segments the rope and forges the segments into individual sweets, which are formed by compressing each segment between two converging dies. The pressed sweets exit the forming head, still soft and enter a cooler, which reduces the temperature of the sweets. The sweets exit the cooler and are transferred to a grading unit, which sorts the sweets into three thickness size ranges. Greater than 8.4 mm, between 8.0 mm and 8.4 mm and less than 8.0 mm. The mid ranged sweets are sent to one wrapping machine (the most sensitive) and the large and small sweets are mixed together and sent to the other two wrapping machines.

19.4.3 Measure

This phase looked at the amount of variation present in the sweets. Since the GO/NOGO gauges did not provide adequate information, a digital variable gauge was purchased with an assessed gauge capability of $\pm 0.002\text{mm}$. The sweet size target was 8.2mm, with an allowable tolerance of $\pm 0.2\text{mm}$, and actual variation exceeded this so the gauge was considered capable for the job.



**Empowering People.
Improving Business.**

BI Norwegian Business School is one of Europe's largest business schools welcoming more than 20,000 students. Our programmes provide a stimulating and multi-cultural learning environment with an international outlook ultimately providing students with professional skills to meet the increasing needs of businesses.

BI offers four different two-year, full-time Master of Science (MSc) programmes that are taught entirely in English and have been designed to provide professional skills to meet the increasing need of businesses. The MSc programmes provide a stimulating and multi-cultural learning environment to give you the best platform to launch into your career.

- MSc in Business
- MSc in Financial Economics
- MSc in Strategic Marketing Management
- MSc in Leadership and Organisational Psychology

BI NORWEGIAN BUSINESS SCHOOL

EFMD
EQUIS
ACCREDITED

www.bi.edu/master

Figure 19.4, shows the Xbar and R charts for sweet thickness measurements from the Product X process, over a period of two weeks and a histogram of the raw data. Note that all sample sweets were kept for inspection and analysis.

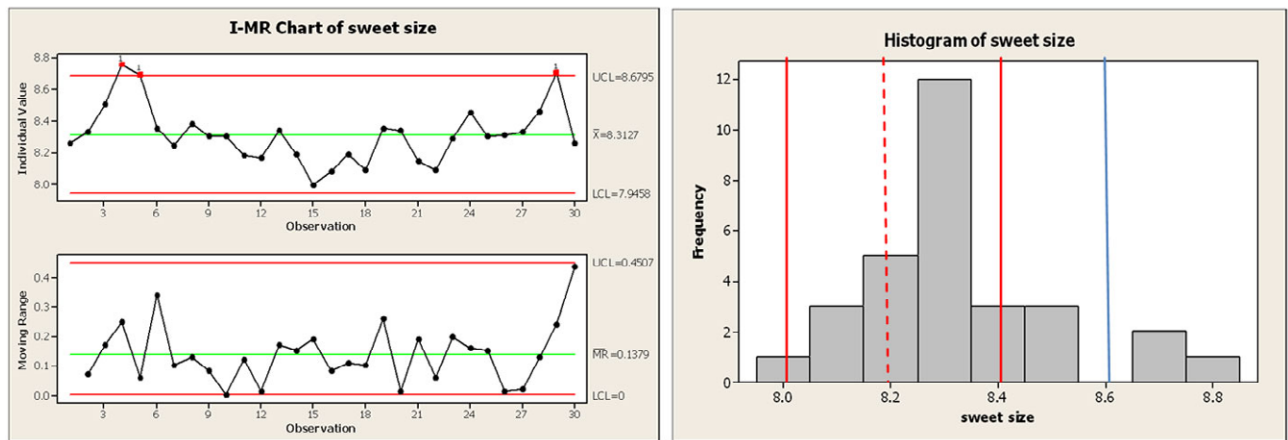

Figure 19.4. iX and mR charts and histogram of sweet sizes for existing processes

In the histogram the red lines represent the new tolerances and the blue the old.

Conclusions from this work were that:

- 1) The process was not stable, with particular problems on the range chart indicating short-term variability issues. Hence, capability could not be calculated.
- 2) 20% of sweets were oversize, giving a DPMO of 200,000 and a process Sigma of around 2.3 (see table in chapter 11)

This led to a focus on special causes that might affect short-term variability.

19.4.4 Analysis of the Distributions

The distribution is skewed (i.e. there were a few very large sweets but no very small ones). These sweets (not surprisingly) correlated with the out of control conditions. It was decided to examine these sweets further to see if they had any distinguishing characteristics. By inspecting the sweets, it could be seen that the 'special cause' sweets had bubbles in them; some of the worst examples had blisters on the outside. Air trapped inside the sweets appeared to be the special cause.

A correlation plot of sweet size against weight confirmed this, with the plot 'flattening off' at the top, as the sweets grew larger due to air bubbles than extra toffee - if size determined weight then the line would not have flattened off so the natural correlation was observed not to be present. It might be worth noting here that observation and sense triumphed over statistical niceties; the R^2 value indicates a correlation between weight and size, however the shape of the plot clearly indicated a different conclusion.

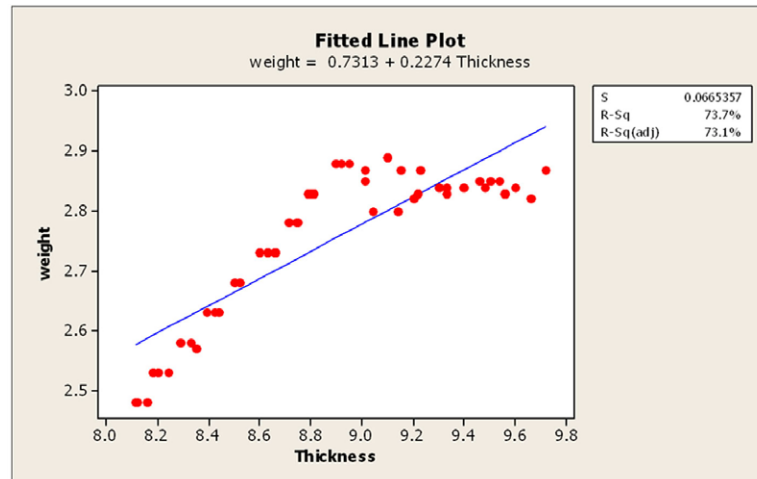

Figure 19.5. Scatter plot of sweet weight against sweet size

19.4.5 Redefining the problem

With a better definition of the problem the team revisited the earlier DMAIC phases. The group started with a brainstorm, following the process flow and identifying where air bubbles could enter the product. This was then collated into a cause and effect diagram (figure 19.6) and the team was split into groups, each of which investigated one segment of the potential problem.

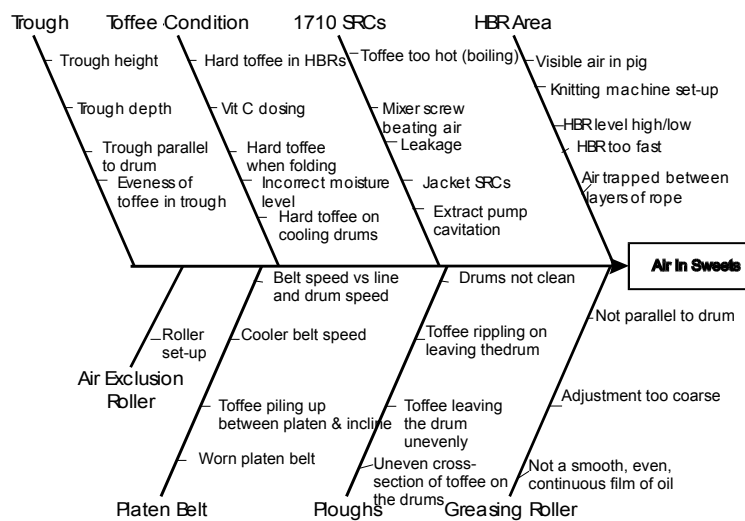

Figure 19.6. Cause and effect diagram for air in sweets

19.4.6 Investigation of findings

The team worked closely with the Product X operators and found three main areas where air was entering the sweets before they were formed:

- Where the molten syrup was poured into the header trough to feed the cooling drum:
 - If there was not enough head in the trough, then gaps would form in the syrup web.
 - If the trough was too wide, then the exiting web would cool too fast and the ribbon of toffee would not merge homogeneously in the extruder.
- As the setting syrup released from the cooling drum:
 - If the oil film on the surface of the cooling drum were uneven, then the toffee ribbon would release unevenly and fold creases into itself, resulting in trapped air.

Need help with your dissertation?

Get in-depth feedback & advice from experts in your topic area. Find out what you can do to improve the quality of your dissertation!

Get Help Now



Go to www.helpmyassignment.co.uk for more info

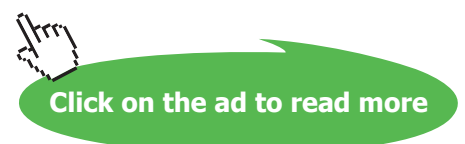

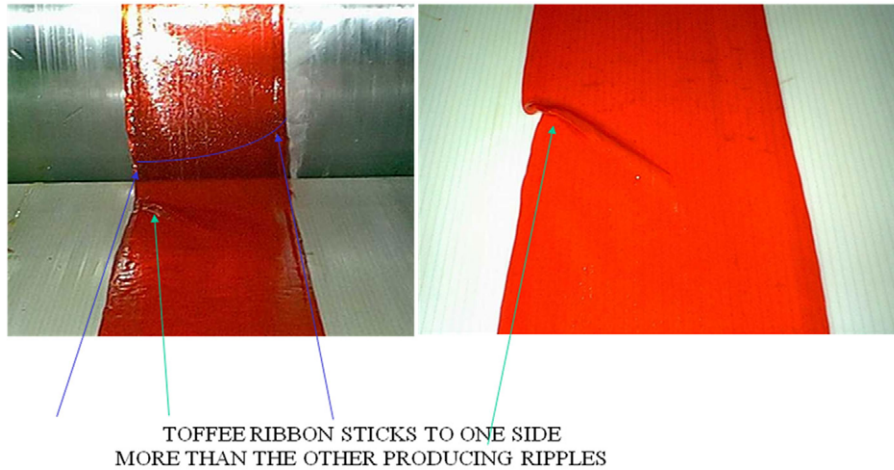

Figure 19.7. Toffee ribbon folding

- As the ribbon of toffee was turned and reduced at the plough area: If the ploughs were set up incorrectly, then air could be trapped inside the reduced ribbon.



Figure 19.8. Incorrect plough set-up

- As the ribbon of toffee enters the extruder (Horizontal Batch Roller H.B.R.):
 - If the toffee is too cold, it will not set homogeneously.
 - If the batch roller is not full, then the rolling mass of toffee will rotate eccentrically, causing air to be trapped in the forming mass.

19.4.6 Analyse: Verifying the root cause

Having derived that air bubbles are a special cause of Product X sweet size variation and identified the potential sources of air in the sweets, the team conducted a series of confirmation experiments to verify that the key triggers for air bubbles had been found and that these had an impact on size variation. The objective was to demonstrate control of the special cause by being able to turn the problem on and then off.

With the production line set up and running in a steady state, the settings of the variables outlined above in section were first put to optimal conditions and then to worst-case conditions. In each experiment, the line was left to settle until the effects of the changes could be seen in the finished sweets, which were measured, weighed and bagged.

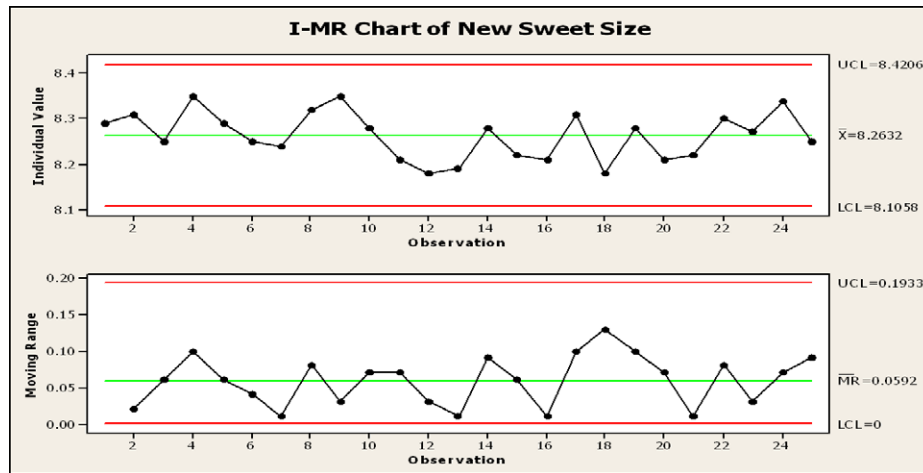

Figure 19.9. Control charts for air exclusion settings

The process was stable, as can be seen in figure 19.9.

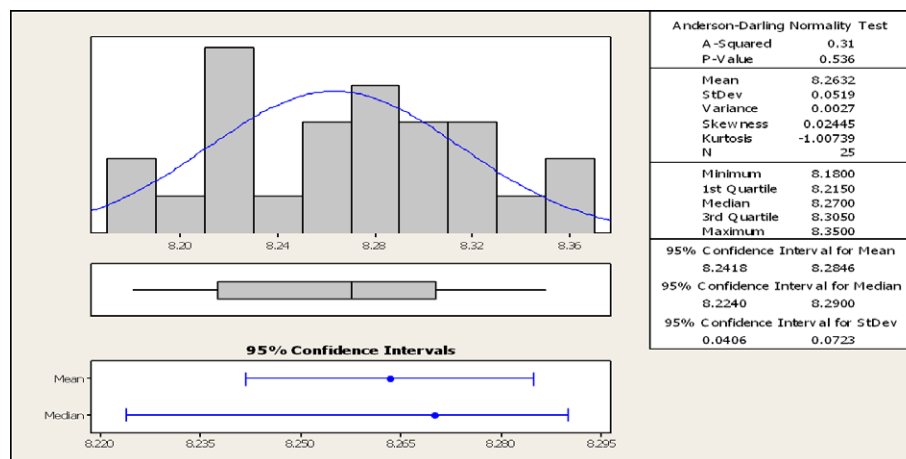

Figure 19.10. Histogram for air exclusion settings

Figure 19.10 shows how the production variation stacks up. Calculated Cp is 1.27 and Cpk 0.87. The process was now producing 4,600 DPMO (0.46%) with a 4.1 process Sigma value.

19.4.7 Improve: Common Cause Variation Reduction

The process was now stable and the process capability vastly improved with DPMO dropping from 200,000 to 4,600. However, the C_{pk} was less than ideal, and the team elected to define and run an experiment to attempt to reduce the common cause variation in the process. The team returned to the original brainstorm and, based on process knowledge and the chemistry of the situation, selected eight possible factors which were investigated at 2 levels each. It is not the purpose of this example to attempt to discuss the chemistry and process factors selected. However, the experimental design and results are reproduced below in figure 20.11. The experimental settings from 1 to 16 were each run for 2 hours and the quality characteristic chosen was the Average Range figure from the SPC chart. This was a measure of the variation in the sweet size produced. Running the SPC chart also served to show that the changes had not introduced instability to the process.



Brain power

By 2020, wind could provide one-tenth of our planet's electricity needs. Already today, SKF's innovative know-how is crucial to running a large proportion of the world's wind turbines.

Up to 25 % of the generating costs relate to maintenance. These can be reduced dramatically thanks to our systems for on-line condition monitoring and automatic lubrication. We help make it more economical to create cleaner, cheaper energy out of thin air.

By sharing our experience, expertise, and creativity, industries can boost performance beyond expectations. Therefore we need the best employees who can meet this challenge!

The Power of Knowledge Engineering

Plug into The Power of Knowledge Engineering.
Visit us at www.skf.com/knowledge

SKF



	1710 Batch Time	Citric Dose	Line Speed	HBR Level	Rework	Mixer Screw Speed	Head	Moisture Level	RESULTS (From SPC Average Range)
1	90 s	13	466	-50mm	LOW	20%	Yellow	1.50%	0.3
2	90 s	13	466	-50mm	HIGH	60%	Red	2.70%	0.37
3	90 s	19	665	+20mm	LOW	20%	Red	2.70%	0.33
4	90 s	19	665	+20mm	HIGH	60%	Yellow	1.50%	0.39
5	90 s	15	466	-50mm	LOW	60%	Yellow	2.70%	0.29
6	90 s	15	466	-50mm	HIGH	20%	Red	1.50%	0.4
7	90 s	23	665	+20mm	LOW	60%	Red	1.50%	0.35
8	90 s	23	665	+20mm	HIGH	20%	Yellow	2.70%	0.36
9	270 s	13	466	+20mm	LOW	20%	Yellow	2.70%	0.31
10	270 s	13	466	+20mm	HIGH	60%	Red	1.50%	0.38
11	270 s	19	665	-50mm	LOW	20%	Red	1.50%	0.3
12	270 s	19	665	-50mm	HIGH	60%	Yellow	2.70%	0.41
13	270 s	15	466	+20mm	LOW	60%	Yellow	1.50%	0.32
14	270 s	15	466	+20mm	HIGH	20%	Red	2.70%	0.38
15	270 s	23	665	-50mm	LOW	60%	Red	2.70%	0.3
16	270 s	23	665	-50mm	HIGH	20%	Yellow	1.50%	0.39

Figure 19.11. Experimental design

The results are shown below in figure 19.12. Only 3 factors investigated appeared to be significant.

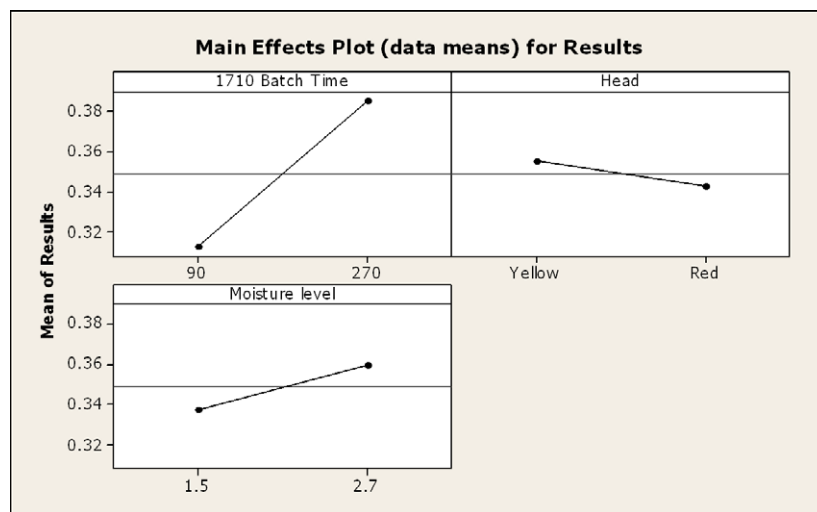

Figure 19.12. Experimental results

However, in practical terms using only one die head and reducing moisture levels would impose significant cost penalties for only small reductions in variation. It was decided at this time not to pursue these, leaving only 1710 Batch time which was reduced to 90 seconds from 270, having a useful additional benefit of reducing cycle time. The new setting was run for a week to confirm the results.

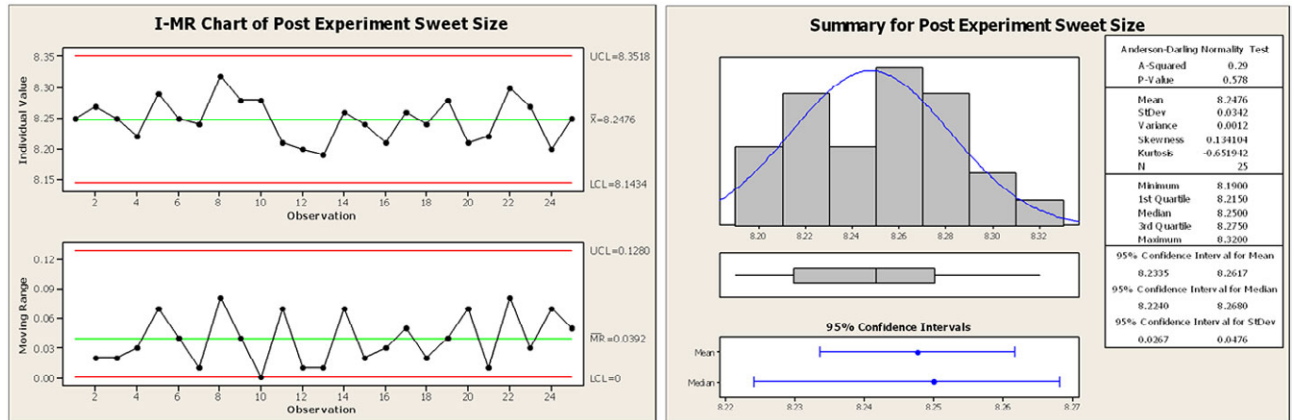

Figure 19.13. ix and mR charts and histogram post experimentation

The process remained stable and had a Cp of 1.91 and a Cpk of 1.46. DPMO was predicted at 10 with a 5.7 process Sigma.

19.4.8 Improve: Laser Micrometer Diagnostic Experiment

As the measurement system set up was focused on finished sweets it was recognised as being a lagging measure. If a problem was found with the sweets, there could potentially be 250 Kg of sweets in the cooler unit, that would either go to waste or be wrapped, leading to the associated performance and quality problems. A leading control mechanism was clearly required.

An experiment was set up using a laser micrometer to determine if air bubbles in the toffee could be identified before the sweets were formed. The process was set up to deliberately fold air into the toffee, thus producing poor sweets and to fold no air into the toffee, thus producing good quality sweets. The sweet size was measured and compared to results from the micrometer, and the results clearly demonstrated that the laser micrometer could detect air bubbles, as a strong correlation between the readings was established. The laser micrometer was deemed effective as a method of achieving predictive control.

19.4.9 Control

The initial scrap costs of £360,000 were virtually eliminated (the DPMO indicating this would be approximately £15). Maintenance costs did not come down to the degree expected so no financial benefits were recorded for this. The total cost of the solutions put in place, training by external professionals and team time over the 2 month duration of the work was estimated at slightly below £13,000.

All personnel affected by the changes were trained, new procedures and care points circulated and specs updated. This was made all the easier by the fact that most of the team were local to the process and were enthusiastic about the changes and the robustness of the process that generated them. An incidental but probably more significant result was the motivation of team members to take the process forward for further projects.

19.5 Summary

The Product X project has delivered a significant improvement in quality and process capability on the line. The financial savings detailed earlier are £360,000pa for investment (including training) totalling £13,000.

In the initial analysis, 1 in every 5 sweets produced in the Product X bay was either scrapped or reworked due to sweet size variation. With the work done in this project, this has reduced to 1 in 100,000. The process capability level has improved from indeterminate to 1.46, and the process is now controlled in a preventive rather than reactive fashion.

In addition to these project-specific benefits, the impact of variation is now more widely recognised in the organisation and the structured DMAIC approach is being used more widely.

In addition to financial benefits, several further aspects of the project were deemed worthy of noting. These learning points were:

- Experienced practitioners who can mentor teams with guidance help keep the teams going in the right direction, at least on their first project.
- A training programme followed by a project is an effective way to allow people to practice and refine what they have learnt.
- Link activity to business measures and quantifiable terms and ensure that the team understands the problem in these terms and can measure their improvements against these metrics.
- Cross-functional and multi-level representation in the teams leads to faster progress and smoother changes in working practices.



"I studied English for 16 years but...
...I finally learned to speak it in just six lessons"
Jane, Chinese architect

ENGLISH OUT THERE

Click to hear me talking before and after my unique course download



This is in line with success factors for Six Sigma outlined by Pande et al (2000) amongst others.

It is also important to note that the team has continued –without prompting- to apply the tools to other problems and opportunities demonstrating their acceptance of the tools and process.

Review & Discussion Questions:

1. *Review the example above; consider:*
 - a. *The strengths of the project*
 - b. *What improvements might have been made.*
2. *Jot down what you think are the key learning points from the example.*

20 Quality by Design (for Six Sigma)

20.1 Introduction

The title of this chapter has a dual meaning; the author believes firstly that the vast majority of the quality characteristics of any product are determined during the design phase of the project and secondly, for many organisations the quality that they achieve occurs by chance and not by design. The purpose is to take the reader through the life cycle of a product from identification of the need to operation in the field. Although these notes are written about the introduction of a new product to the market place, all of the concepts apply equally to a service.

Design for Six Sigma (DFSS, or Quality by Design) can be applied in two situations:

- **When designing a new product, service or process:** By giving attention at this early stage to customer satisfaction and variability reduction breakthrough changes can be achieved.
- **When traditional Six Sigma cannot achieve sufficient improvement:** Due to the limitations of working with an existing process it may not be possible to reach acceptable Sigma levels. There is a commonly held view that Six Sigma can only get a process to 5 Sigma levels and to reach Six Sigma we need to apply DFSS. This is spurious (as can be seen from the example project in this book) but the general principle that DFSS can deliver higher Sigma levels holds because it delivers more leverage and more options as discussed below.

20.1.1 Leverage

The design stage has much more leverage for improvement than the latter stages, as decisions made here have a disproportionate effect on design quality and customer value.

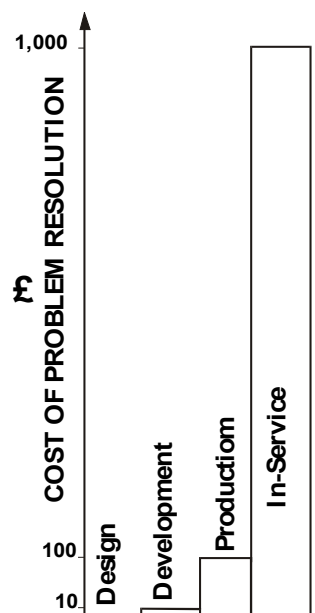

Figure 20.1. The cost of problem resolution.

Figure 20.1 shows the relative cost of solving a problem in different phases of the design process. It is derived from information gathered during aerospace projects, but has become widely accepted throughout industry. During the design phase potential problems with the design will be identified and usually the cost of resolving these changes will be small if they are identified early enough so that consequential changes are minimised. If a decision not to make a particular change is made for whatever reason, for every £1 that would have been spent in the design phase, £10 will have to be spent in the development phase if it is decided that the change is necessary after all. If it is not until production that a decision is made to implement the same change, the cost is now £100 for every £1 that it would have cost in the design phase. Finally, that same change would cost 1000 times more if a decision is made to correct items already delivered to the customers. Figure 20.1 is **drawn to scale and yet the** representation of in-service problem resolution costs is conservative because these are the costs associated with product recalls, or if the item is subject to dealer service, a free modification at the next scheduled service. All of the problems that do not justify such drastic action are not resolved for countless customers who have to put up with the standard of the product as they purchased it. Consequently, there is likely to be a hidden cost of not resolving problems that customers subsequently have to live with, namely, the costs associated with dissatisfied customers who may not only fail to buy the same product again, but also publicise their dissatisfaction to their friends.



What do you want to do?

No matter what you want out of your future career, an employer with a broad range of operations in a load of countries will always be the ticket. Working within the Volvo Group means more than 100,000 friends and colleagues in more than 185 countries all over the world. We offer graduates great career opportunities – check out the Career section at our web site www.volvogroup.com. We look forward to getting to know you!

VOLVO
AB Volvo (publ)
www.volvogroup.com

VOLVO TRUCKS | RENAULT TRUCKS | MACK TRUCKS | VOLVO BUSES | VOLVO CONSTRUCTION EQUIPMENT | VOLVO PENTA | VOLVO AERO | VOLVO IT
VOLVO FINANCIAL SERVICES | VOLVO 3P | VOLVO POWERTRAIN | VOLVO PARTS | VOLVO TECHNOLOGY | VOLVO LOGISTICS | BUSINESS AREA ASIA

Download free eBooks at bookboon.com



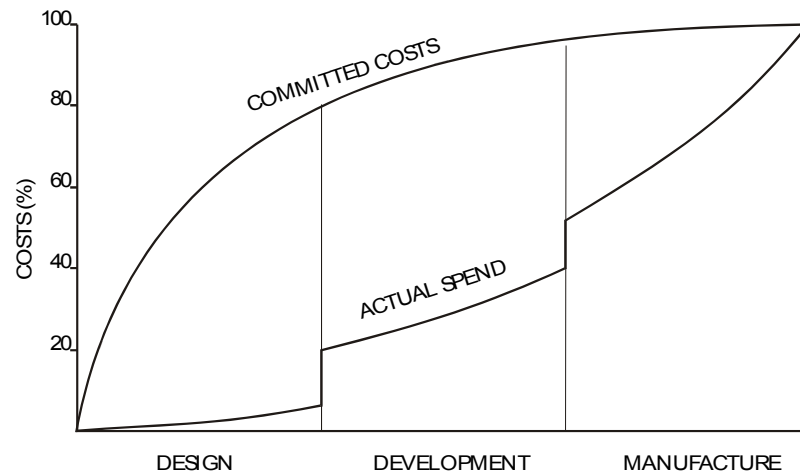

Figure 20.2. Committed costs vs. actual spend (Adapted from Yang and El-Haik, 2003)

Figure 20.2 shows a typical relationship between the committed costs and actual spend during a product development programme of military aerospace equipment, but the author believes that there would be little difference in the shape of these curves in most product sectors.

The important concept here is that for most programmes, the design phase is conducted with minimal actual expenditure. Design teams have tended to be small in the early stages of the programme and financial commitment to the project occurs at a relatively late stage, often after early prototyping has commenced. The problem with this approach to product development is that experience shows that about 80% of the future costs associated with the product are likely to be committed by the end of the design phase, the stage during which minimal resources are expended. During the development and production phases when actual expenditure ramps up sharply, there is a decreasing opportunity to make changes which significantly affect the outcome of the programme.

20.1.2 Options

When we are improving an existing process certain of the parameters we could control are out of scope. We cannot, for example, reasonably change the shape of a car panel as this would not only be very expensive, but would be highly disruptive to production. If we begin to work on customer focused, variability minimized products and services at the design stage we have much more flexibility in terms of what we can control.

20.2 The DFSS Process

Design for Six Sigma is not meant to replace the existing New Product Introduction (NPI) process, it is meant to support that process by ensuring the same focus on process, variation and customer as is evident in standard Six Sigma.

The DFSS methodology begins by finding and analysing the gaps in processes that are negatively affecting new product performance. It also focuses on customer response to the product. Once this has been completed the project to tackle the problems can be established.

The process for solving problems is called DMADV i.e. **D**efine, **M**easure, **A**nalyse, **D**esign and **V**erify or sometimes it is called PIDOV i.e. **P**lan, **I**dentify, **D**esign, **O**ptimise and **V**alidate.

Essentially these are approaches to designing products, services and processes to reduce delivery time and development costs, increase effectiveness and better satisfy customers. The basic procedure is outlined as follows:

- Capture customer requirements;
- Analyse and prioritise requirements;
- Develop design;
- Flow down requirements from the system level to sub-systems, components and processes;
- Track the product capability at each step;
- Highlight any gaps between requirements and capabilities and make these actionable; and
- Establish a control plan.

The two methodologies mentioned above have the same objectives and are both rigorous in nature; their only real difference is in terminology. Most industrial organisations will have some version of this process and this is usually known as the New Product Introduction Process (NPI).

20.3 The Voice of The Customer

20.3.1 Quality Function Deployment

QFD was covered in some detail in chapter 13. Important as it is in improving an existing process, service or product, it is even more significant when we are considering a new design. In the Identify phase of PIDOV and the Define phase of DMADV the voice of the customer is analysed using QFD to focus the design/development effort on important criteria.

20.3.2 Load/strength Relationships

A technical addition to QFD in the design process is the concept of load/strength relationships. Once we understand what the customer wants we need to assess the load model on the understanding that some customers will stress the product more than others and some products will be less robust than others due to manufacturing variation. The series of diagrams which follow show what we are attempting to achieve when designing a new product, and indicate ways in which our intentions are not met.

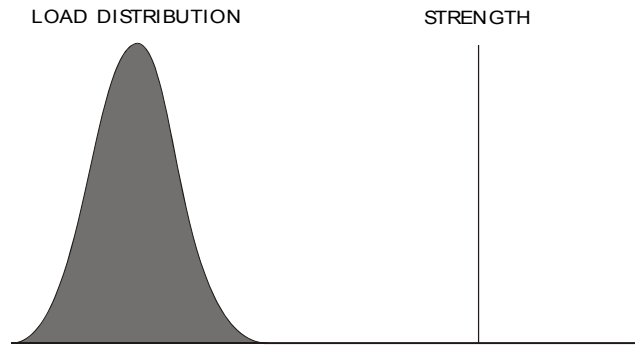

Figure 20.3. Ideal relationship.

Figure 20.3 shows the ideal situation in which a product has an undistributed strength that is greater than the highest of the loads expected from the load distribution. This situation would result in an inherently reliable product that did not fail in service.

qaiteye[®]
Challenge the way we run

EXPERIENCE THE POWER OF FULL ENGAGEMENT...

**RUN FASTER.
RUN LONGER..
RUN EASIER...**

**READ MORE & PRE-ORDER TODAY
WWW.GAITEYE.COM**



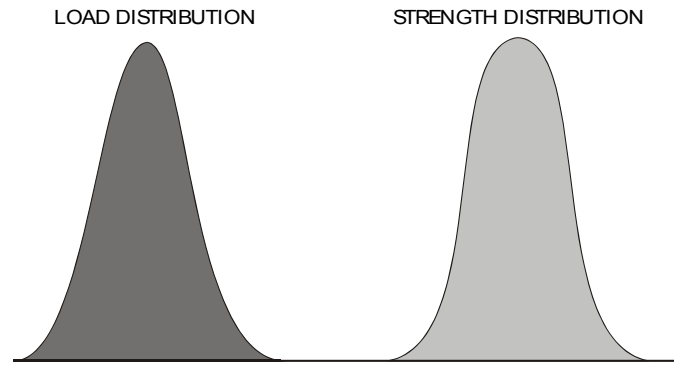

Figure 20.4. A more realistic relationship.

Figure 20.4 is a more realistic version of Figure 20.3 in which it is acknowledged that not only are the loads which a product experiences distributed but so is the strength of the population of product that have been manufactured. In fact, we know that variability exists in everything, and what we are attempting to do is to manufacture a product with as little variability in its characteristics as possible.

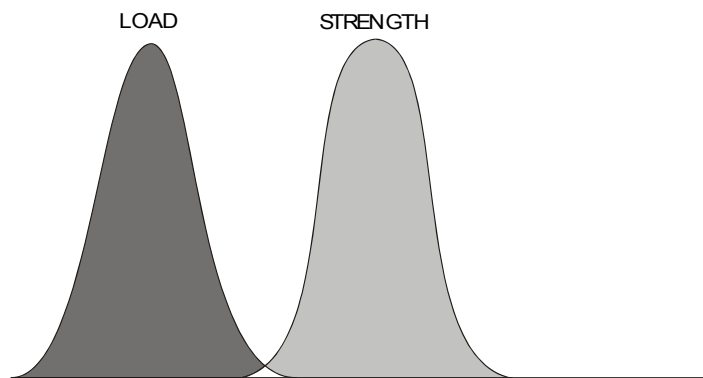

Figure 20.5. An inherently unreliable design.

If Figure 20.5 represents the situation at product launch, an inherently unreliable design is depicted. Failures will occur when the weakest products meet the highest loads, and this could occur as the first products enter the market place. On the other hand, if Figure 20.5 represents the situation after a number of years of use, age-related degradation is represented. For example, a product depicted by Figure 20.4 at launch could gradually weaken with age so that the distribution “slips” to the left. Dependent on at what stage in the product’s life this occurs, this may be acceptable to the user as failures will start when the “tails” of the two distributions overlap.

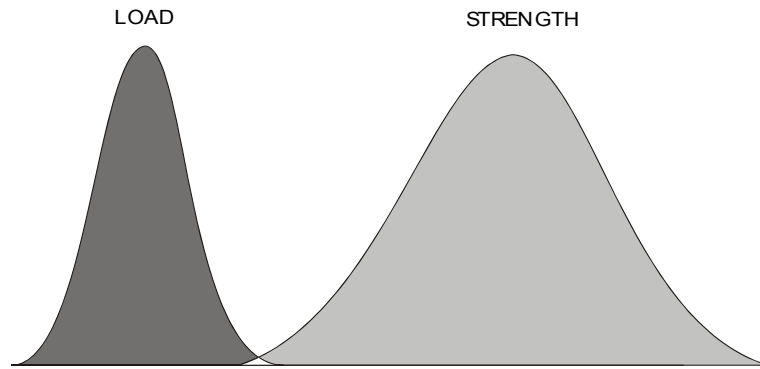

Figure 20.6. Effect of incapable processes.

Figure 20.6 shows an inherently reliable design (the mean strength is similar to Figure 2) but the incapable manufacturing process has increased the variability in strength. The process may be assumed to be in control because the strength is singly distributed.

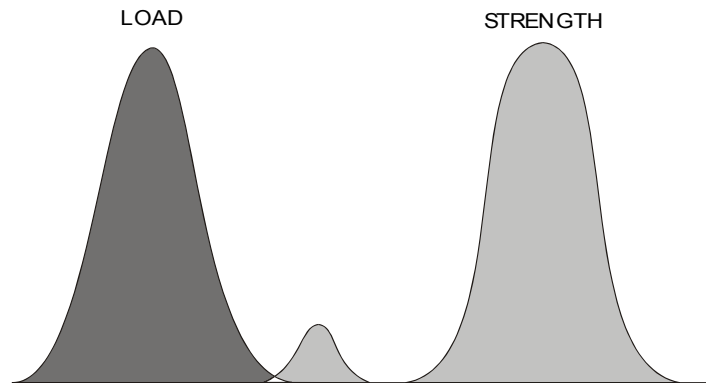

Figure 20.7. Effect of out-of-control processes.

Figure 20.7 shows an inherently reliable design that appears to be manufactured by capable processes because there is no increase in the spread of the strength distribution. However, the manufacturing process is out of control as evidenced by the small “freak” distribution of weaklings. This sub-population will fail early in service as the highest loads cause premature failure.

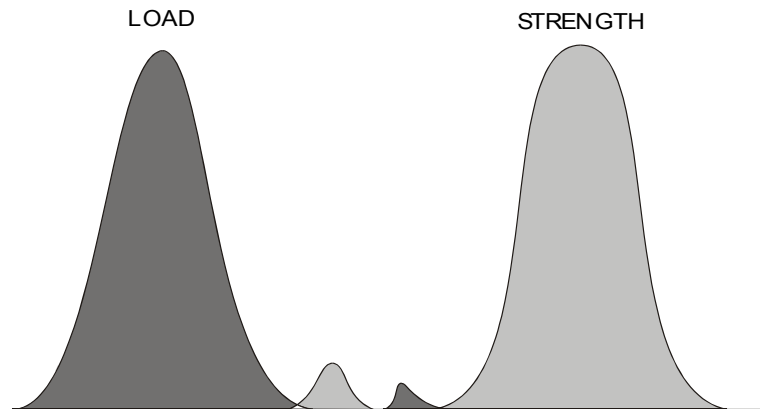

Figure 20.8. The effect of abuse.

Figure 20.8 shows the same situation as Figure 20.7 and, in addition, recognises that although the design is inherently reliable, some early life failures may be caused not by weak products from an out of control process, but by use of the product beyond the expectations of the design and marketing team. This is shown by the small “freak” load distribution depicting abuse of the product by the customer.



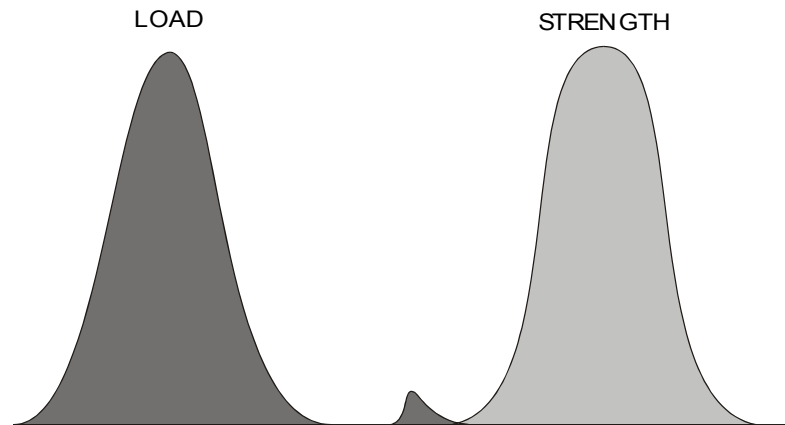

Figure 20.9. Best achievable situation?

Finally, Figure 20.9 perhaps represents the best situation that we can achieve. It would be exceedingly difficult to determine the degree of abuse and even if it were possible to do so with any confidence, to design for excessive abuse would result in an over-engineered product for the vast majority of users. The resulting cost increases may also make the product non-competitive. Before considering how best to achieve this situation, it is useful to understand a number of major factors that influence significantly the achievement of reliable, quality products.

In DFSS we need to understand both load and strength curves to assess the viability of the design.

20.4 Impact of Late Design Changes

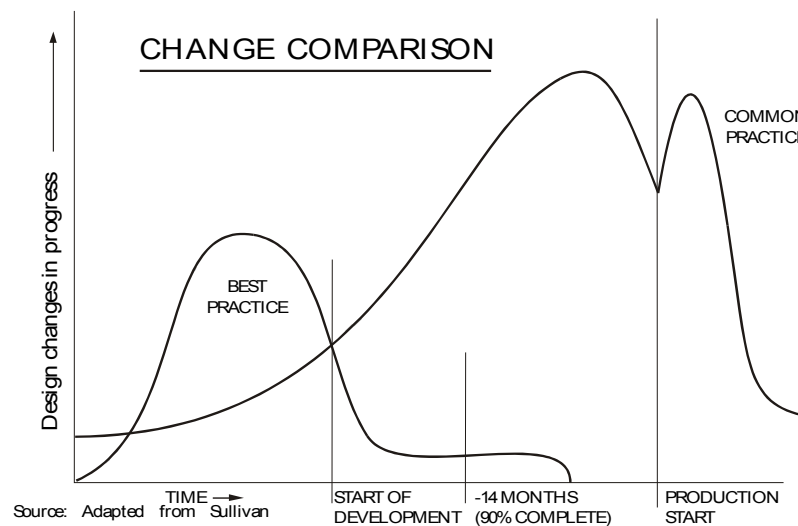

Figure 20.10. Design change profile. (Adapted from Yang and El-Haik, 2003)

Figure 20.10 is a conceptual plot of how typical and successful companies implement design changes through the product life cycle. Common practice companies tend to start a programme with minimal resources and consequently implement design changes at a low rate until the start of the development phase when prototypes are tested. This is also the time at which full financial approval is given to the project, and the rate of design changes increases until it peaks just short of production when *it is too late to make further changes*. However, shortly after the start of production it is realised that there are some changes that are absolutely essential, as shown by the second, slightly lower peak of design activity. This late attempt to get the product right drops off quite quickly because the expense involved means that only the essential changes are justified. In contrast, the best practice company quickly ramps up its design effort by employing multi-disciplinary teams very soon after project start. As the development phase approaches, the best practice team is experiencing a decreasing rate of design changes. Development is undertaken to prove the design changes made during the previous phase and well before production commences, design activity comes to an end. From previous discussion it can be seen that the cost of design changes to the best practice company is considerably less than for common practice companies. Also, although Figure 20.10 is shown with a single timescale, the improved right first time rate for the best practice company will enable it to develop products quicker. This diagram is not meant to state that best practice companies never make design changes during the production and in-service phases of a product's life; it is a conceptual plot in which the scale of design changes during these phases is so low compared to our performance, that they could be represented by a line co-incident with the x-axis. Many Western organisations have long recognised the need to increase the up-front effort, thereby improving product quality and reducing the need for large product support functions. The transition phase from old to new-style project management is difficult because products still in service have to be supported while the organisation tries to increase the size and capability of the design function, and usually this has to be attempted without any net increase in the organisation's personnel. One of the options that the organisation must consider is to market fewer products during the transition period, but those projects that do gain approval are conducted with a steadfast commitment to early design changes.

It is worth noting that both the 'good' and 'bad' approaches described above are reinforcing cycles; as long as the existing products have problems to be fixed it will draw resource away from new products, leading to a poor upfront design effort, leading to error and so on. Similarly if we put the right effort in up front we should avoid problems and thus have resource available for future projects.

20.5 Design for 'X'

DFSS applies a generic process called Design for X to a large number of issues which need simultaneous consideration with respect to both design and verification. Examples of these are:

- Design for Manufacture.
- Design for Assembly
- Design for Reliability
- Design for Maintainability
- Design for the Environment
- Design for Lifecycle Cost

These issues are treated much as any other design requirement, but they have often, in the past received insufficient consideration.

20.6 DFSS Tools

DFSS has a number of tools which are particularly associated with it. Many are the same as in standard Six Sigma, but used more and to greater effect (QFD, Design of Experiments, Process Capability Analysis) whereas others are specifically useful in design (TRIZ, Failure Modes, Effects and Criticality Analysis, Pugh Matrix). In many cases the tools applied in DFSS are more technically challenging and require more effort.

20.7 Summary

DFSS is not a major part of this book, it is included as a recognition that Six Sigma deals with existing processes and is thus somewhat limited in scope and potential. DFSS takes Six Sigma thinking into the design process and can generate significant additional benefit and breakthrough levels of performance.

Review & Discussion Questions:

1. *What benefits does DFSS have over the traditional DMAIC approach?*
2. *How might DFSS be applicable in a service environment?*
3. *In your view, would it be best for an organization to launch DMAIC or DFSS first, or should they be launched together?*

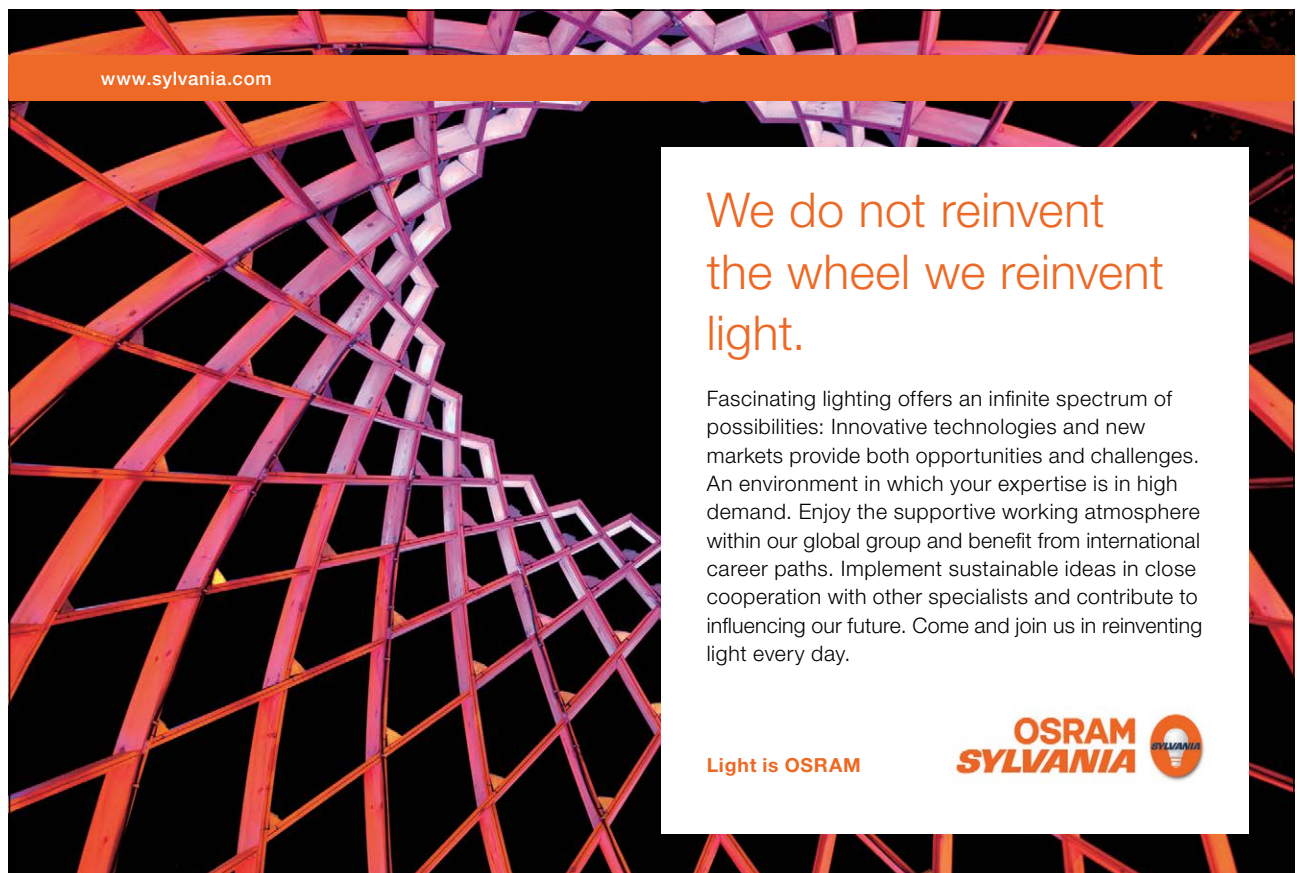

www.sylvania.com

We do not reinvent
the wheel we reinvent
light.

Fascinating lighting offers an infinite spectrum of possibilities: Innovative technologies and new markets provide both opportunities and challenges. An environment in which your expertise is in high demand. Enjoy the supportive working atmosphere within our global group and benefit from international career paths. Implement sustainable ideas in close cooperation with other specialists and contribute to influencing our future. Come and join us in reinventing light every day.

Light is OSRAM

**OSRAM
SYLVANIA**



21 Six Sigma: A Critique

21.1 Introduction

Six Sigma literature tends to present overwhelmingly ‘how to’ techniques along with the positive aspects of this approach and, with very few exceptions, avoids discussing its problems and failures (McAdam & Lafferty, 2004). Thus, the majority of Six Sigma literature can be described as introductory, dealing with elementary principles of Six Sigma and ‘selling it as a valuable management philosophy’ (Goh, 2002; Banuelas et al, 2005). This creates certain difficulties with critically assessing Six Sigma.

However, there is some evidence that Six Sigma has some negative aspects (Lee, 2001). This critique draws on publications critiquing Six Sigma and on those that propose amendments and extensions to Six Sigma concept. The logic of this is that, by proposing modifications and extensions the authors imply (if they do not state explicitly) gaps and issues with existing Six Sigma principles or practices. Examples of attempts to integrate Six Sigma with other quality improvements approaches include: TQM (Hammer and Goding, 2001; Revere and Black, 2003), Human Resource Functions (Wyper and Harrison, 2000), Lean Production (Antony et al., 2003), EFQM BEM (Raisinghani et al, 2005), ISO standards (Catherwood, 2002; Dalglish, 2003) and even the capability maturity model (Murugappan and Keeni, 2003).

21.2 Accepted Strengths of Six Sigma

These have been discussed at some length already, but a few bullet points will serve to remind:

- Strong links to strategy.
- High levels of management focus.
- Key roles allocated to create focus supported by structure and skills training.
- Linking improvements in quality to business benefit.
- Focus on customers.
- Focus on variability.
- Process driven.

21.3 Reasons for Failure and Critical Success Factors

There is beginning to be some recognition that Six Sigma does not always work. Gupta (2008) suggests that as many as 60% of all Six Sigma initiatives fail to yield the desired results. Zimmerman and Weiss (2005) note that less than 50% of aerospace companies are satisfied with their Six Sigma programmes. It should be noted, however, that detailed information about Six Sigma failures is rather scarce and is mainly found on the web sites of consultancy critiquing approaches by ‘other’ companies. For example, the Six Sigma Academy offers the following list of reasons for failed projects (Gilbert, 2002):

- Lack of commitment from top management;
- Using part-time instructors;
- Having projects tied to insignificant criteria;
- Setting incorrect targets, perhaps based on the number of people trained and certified rather than on bottom-line results;

- Poor project management;
- Treating Six Sigma as a “quality” initiative, which creates cynicism;

This list may be enlarged by Eckes’s (2001) claim that 60 per cent of projects failed due to ignoring people issues, particularly team dynamics (the motivating and driving forces that propel a team toward its goal or mission). He names several problems that typically occur while performing Six Sigma:

- Difficulties with identifying a leader.
- Difficulties with developing rules and agenda for meetings.
- Difficulties with defining objectives and responsibilities of each member.

For a more complete picture we can consider Six Sigma Critical Success Factors (CSFs) – the issues one has to take into account to avoid failure. There are several sources containing information about Six Sigma CSFs (Henderson and Evans, 2000; Pande et al., 2000; Eckes, 2001; Banuelas and Antony, 2002; Antony and Banuelas, 2002; Goldstein, 2001; Lee, 2002; Voelkel, 2005). The number of CSFs varies from 7 (Henderson and Evans, 2000) to more than 20 in some research. Let us summarize the CSFs mentioned by various authors and consider them in the descending order of significance discovered in the research made by Antony and Banuelas (2002).

Management commitment and involvement, which are visible and public, is by far the most crucial factor for Six Sigma success according to the majority of authors. This notion is supported as by much empirical research (Banuelas and Antony, 2002; Lee, 2002; Henderson and Evans, 2000) and by the position that is expressed by many Six Sigma ‘gurus’ (Eckes, 2001; Pande et al 2000) who identify management commitment and involvement as the most vital ingredient of Six Sigma success. As Hahn (2005) states ‘the enthusiastic commitment of top management is essential’. This result also agrees with the study performed on GE experience (Henderson and Evans, 2000), where management participation in Six Sigma has various forms: from sudden top managers’ visits to regular 6s reviews meetings and different manufacturing sites to talk with shop floor workers, to GE CEO spending time ‘in every Six Sigma training wave, speaking and answering questions for students’. Voelkel (2005) also emphasises the importance of effective leadership at Six Sigma project level, as well as initiative level, as does Snee (2005).

In the research performed by Antony and Banuelas (2002) ‘understanding Six Sigma tools and techniques’ was marked second by the people who took part in this survey. It is of interest, that ‘training’ occupies the position at the bottom of the importance list, despite the apparent linkage. The difference between the importance of understanding Six Sigma, ability to apply its tools efficiently and training reflects one of Six Sigma noticeable problems – high cost of its training programs. As Senapati (2004) states ‘the high cost of Six Sigma training creates a barrier for spending and prevents the implementation of this improvement program’. However, many Six Sigma practitioners (e.g. Henderson and Evans, 2000) highlight the importance of providing the employees with sound and thorough training. The research conducted by Lee (2002) supports the point that that quality of training, including team work skills training, is one of the most important Six Sigma CSFs. GE experience also suggests that training in DMAIC along with appropriate tools is vital (Henderson & Evans, 2000). Hahn (2005) also recommends ‘invest in relevant hands-on training’. Proper training is supposed to ensure the appropriate usage of tools, which is another Six Sigma CSF (Antony, 2006).

Black Belt selection is another Six Sigma CSF according to Lee (2002), who claims that a candidate's personality is by far the most important aspect for Black Belt selection; well ahead of educational background, statistical or quality experience. Other important criteria for Black Belt selection are: project management skills, skills in managing a multidisciplinary team, and communication skills

The fifth CSF - project prioritisation, selection and tracking is considered by many other authors to be important (Pande et al., 2000; George, 2002). There are various criteria for project selection; Lee (2002) offers a reasonably comprehensive list of project selection criteria:

- The problem is of major importance to the organization.
- The project has a reasonable scope (doable in three to six months).
- The project defines clear quantitative measures of success.
- The project's importance is clear to organization.
- The project has support and approval of management.



360°
thinking.

Deloitte.

Discover the truth at www.deloitte.ca/careers

© Deloitte & Touche LLP and affiliated entities.



The next CSF, 'project management skills', closes the group of factors connected with project selection, executing and tracking. Lee (2002) suggests that there are two main issues that contribute to fulfilment of this CSF: first of all Black Belts should be given project management training; secondly, the projects should be reviewed frequently by Master Black Belts and Champions. Hayes (2006) also recommends the following measures of project management and tracking:

- Establish a documented 1-year Six Sigma project inventory (and refresh regularly);
- Assign a Champion and Black Belt to each project (and hold them accountable);
- Implement a project tracking system to facilitate replication and reuse;

The next CFS is 'organization infrastructure' which is defined by Henderson and Evans (2000) as the number of measures that are supposed to implement and ensure effective work of belt structure. It is worth noticing that the cost of deployment may be a serious obstacle; for UK SMEs, for example, the cost of implementation was mentioned as one of the most serious barriers to Six Sigma implementation (Antony et al, 2005).

Along with the infrastructure, communication is an extremely significant factor for Six Sigma success. An ideal Six Sigma implementation plan implies early communication to all the employees the necessity for change and benefits that this change may bring to the company. GE experience stresses the importance of early communication of Six Sigma approach to all employees (Henderson and Evans, 2000). These authors state that early communication reduces the resistance of employees and, as a consequence, leads to a more successful Six Sigma implementation. However, it is also possible to interpret the impact of communication as increasing people's involvement that contributes to the overall Six Sigma success. Goldstein (2001) illustrates this point, saying 'if the program launch makes the general employee population feel left out, it will be difficult to gain its support and contribution when the need arises later on—and it will arise'. He proposes the following plan for communicating Six Sigma initiatives:

- What Six Sigma is and why the organization is embarking on this journey.
- What the business goals are and what the deployment plan is.
- How each employee will be able to participate.

Hayes (2006) offers even more detailed list of measures that support Six Sigma when it has been already deployed:

- Creation and communication of a Human Resources plan to support Six Sigma roles.
- Regular written communications on Six Sigma news and successes.
- Development and dissemination of communication aids to management.
- Advocating and creating a "common language" based on Six Sigma.

Communicating pertinent facts about Six Sigma in every company meeting.

Without good communication the next CSF – cultural change cannot be achieved. As Hahn (2005) states 'make Six Sigma pervasive, and involve everybody'. Cultural change is often named as the ultimate aim of Six Sigma in many publications (Pande et al.,2000; George, 2002) which makes it being a CSF somewhat tautological, however, the importance of cultural issues is supported by Lee's (2002) research suggesting that if company has already practiced TQM, Lean or SPC the implementation of Six Sigma is generally more successful.

Kwak and Anbari (2006) also claim that addressing cultural change is one of the most important CSFs. However, it tends to be one of Six Sigma weakest aspects, mainly due to its initial 'process-focus' origin. It is of interest, that some Six Sigma 'gurus', for example Eckes (2001), address this issue identifying the 'resistance' aspect of Six Sigma deployment and proposing some measures to 'reduce or eliminate' it. However, it seems preferable to focus on early Six Sigma communication and involving people in a much more positive way.

The table below summarizes Six Sigma CSFs and separates CSFs that influence the overall success of Six Sigma initiatives from the factors that mainly affect the success of Six Sigma projects:

6S CSFs	Corresponding failure reason according to Six Sigma Academy (Gilbert, 2006)
Initiatives CSFs	
Top management involvement and commitment	Lack of commitment from top management
Understanding Six Sigma tools and the quality of training given to the employees	Using part-time instructors;
Linking Six Sigma projects to the company overall strategy and the customer needs;	Having projects tied to insignificant criteria; Setting incorrect targets, based on the number of people trained and certified rather than on bottom-line results;
Selecting of BBs	Wrong team
Organizational structure that provides communication possibilities and supports teamwork culture	n/a
Linking Six Sigma to HR policies	n/a
Cultural issues should be addressed and lead to a cultural change	Treating Six Sigma as another "quality" initiative, which creates cynicism
Implementation should be 'right' – that gains people's commitment	Using part-time instructors; Wrong implementation that does not gain people's commitment;
Projects CSFs	
Project leadership and management	Having projects tied to insignificant criteria Poor project management;
Project should be focused on the essential business processes	Having projects tied to insignificant criteria;

Table 21.1. CSFs and reasons for failure

21.2 Inherent Conceptual Issues

The last section looked at CSFs and considered how to get the best from Six Sigma, but it behoves us to also consider whether there are inherent issues in the approach. Many companies such as Motorola, Kodak, Honeywell that achieved considerable savings and improvements in quality, nevertheless, have been facing declining revenues and loss of market share (Abramowich, 2005). At the same time quality-leading companies like Toyota choose not to adopt Six Sigma. Additionally, despite the declared savings, Six Sigma does not significantly affect company stock price (Goh et al, 2003). So what are the inherent issues?

21.2.1 Creativity and Innovation

Six Sigma focuses on optimising what you have, potentially at the expense of innovating for the future. This statement may be illustrated by several examples describing how new innovative products such as computer scanners, email, electronic photography, digital imaging, colour printers, computer networking have pushed quality enhanced by Six Sigma copiers, film and phones made by Xerox, Kodak, Polaroid and Motorola to the margins (Shelley and Wilson, 2002). Another example may be the history of International Business Machines Corp. (IBM); Gilbert (2002) claims Six Sigma was almost a religion there in the early 1990s and the focus was almost solely on improving products quality. That resulted in winning a Malcolm Baldrige Quality Award at the facility in Rochester. However, it did not help the company to stay in business due to the fact that 'IBM was, in many cases, building the wrong products' (Gilbert, 2002). For example, while IBM was reducing the defects in its networking equipment, Cisco Systems Inc. introduced a new type of networking equipment, known as routers. While IBM was making incremental improvements to its disk drives, EMC Corp. was developing a completely new approach (known as RAID) for redundant arrays of inexpensive disks. As a result Cisco and EMC experienced unprecedented growth and took the leading position in the markets away from IBM. Moreover, research done by Cho and Pucik (2005) shows that innovativeness is closely connected with growth, whereas quality has only a limited impact on it. Goh (2002) states 'Six Sigma is called for when avoidance of non-conformance is of higher priority than breakthrough and creativity'.

SIMPLY CLEVER





Do you like cars? Would you like to be a part of a successful brand?
We will appreciate and reward both your enthusiasm and talent.
Send us your CV. You will be surprised where it can take you.

Send us your CV on
www.employerforlife.com

Anderson (2006) notes that the economic focus of Six Sigma distracts from customer satisfaction, leading to a focus on only current static CTQs and lack of attention to unexpected or 'delighting' features (as in the Kano quality model); little reference to varied customer expectations or lifestyles; not anticipative of technological, social, or business changes (Goh, 2002). This fact was admitted by several Six Sigma practitioners. For example, GE CEO Jeff Immelt (2005) claimed 'we want to make it O.K. to take risks and do things that aren't just going to [produce results] this quarter'. All these factors result in the fact that Six Sigma in its current form not only lacks innovation and creativity but even suppresses it.

The same opinion is expressed by Jay Desai (Cited in Flaherty, 2004), who helped implement Six Sigma at conglomerate General Electric Co and currently runs the Institute of Global Competitiveness, "Six Sigma is not a solution for new products or a breakthrough strategy". Moreover he claimed that "Six Sigma does not create innovation". The most vivid example of how negatively Six Sigma can affect the company innovation is Lucid Technologies that decided not to adapt Six Sigma due to its focus on developing new innovative products (Abramowich, 2005).

21.2.2 Limiting Learning

Six Sigma can negatively affect various aspects of learning within an organization. First of all, Six Sigma may reduce learning options only to single-loop learning (i.e. fixing problems) rather than double-loop learning which challenges norms and produces breakthroughs (Argyris, 1994). This happens due to the fact that Six Sigma projects are overwhelmingly focused on fixing problems and providing quick financial benefits (an average Six Sigma project lasts about six months) rather than exploring long-term perspectives (Abramowich, 2005). The research done by Juran Institute had studied several companies that practice Six Sigma shows that 'benefits are being generated almost entirely on an internal cost reduction basis' (Juran Institute, 2003).

Finally, it seems that Six Sigma is able to create a certain atmosphere that prevents learning and open discussion. There are several factors that lead to such result. First of all, the implementation of Six Sigma initiatives is usually highly top down. The company top management having made considerable investments in creating Six Sigma infrastructure, expects to receive a good return on these investments through Six Sigma projects. These expectations create a certain pressures on the employees that lead to the situation where 'savings due to Six Sigma are over counted, but management has made people afraid to speak their true opinions. Those who do so risk damage to their careers and are labelled 'not team players' Rasche (2001). Thus, expectations of high ROI often inhibits open discussions that are an integral element of the learning environment.

Secondly, Six Sigma due to its focus on 'low hanging fruits' often creates a culture of 'if it is not broken, don't fix it' (Abramowich, 2005) that implies that projects are initiated to fix the problems that are visible and obvious. This also inhibits discussion on the issues that require long term efforts or do not promise instant results.

Finally, another major contribution to inhibiting learning is made by Six Sigma management system that may be characterized as command and control management system (Seddon, 2006). Seddon (2006) describes Six Sigma as 'hierarchical direction (command) and reporting (control) structures'. Such principles of management mitigate against an OL environment that requires people's involvement in making decisions and implementing them. Thus, this system may isolate the employees from several stages the learning cycle. Besides, due to highly stressed financial focus this system can often facilitate frauds in reporting. As Seddon (2006) claims people 'learn to report any good news as related to a Six Sigma project' in order look good in reports that look 'as though things are improving'. However, add Seddon (2006) such

'improvements' 'are nothing compared to changing the system and often the 'improvements' are actually making things worse'. This situation is reflected in a difference in perception of Six Sigma by management and by workers noticed by some scholars (McAdam & Lafferty, 2004) and that can be more vividly revealed by reading the blogs of the employees who experience Six Sigma implementation (some examples are collected by Shelley and Wilson, 2002).

21.2.2 Anti-Involvement

Often touted as a way of involving everyone in an organization in improvement some scholars (e.g. Klefsjo, 2001) suggest that the opposite is not true due to an over-reliance on Six Sigma belts structure at the expense of total involvement.

Despite the comments by many scholars, for example Kwak and Anbari (2006), on the importance of continuous education and training for every employee (not only for belts), Six Sigma can limit learning among the employees to development and education of only the belted employees. According to several researchers this happens quite often and in many Six Sigma companies learning is mainly limited within the group of Six Sigma specialists (McAdam, 2005; Wiklund and Wiklund, 2002). Even for Master Black Belts and Black Belts learning is often reduced to training (McAdam, 2005) that reduces the learning capacity of the system to the learning capacity of Six Sigma belts. As Bicheno and Holweg (2009) pointed out, the perceived elitism of Six Sigma was a key reason for Toyota regarding it as not appropriate for their high quality organization.

21.3 The Future

Six Sigma is constantly evolving. New combinations spring up in seemingly endless numbers. Some are superficial in the extreme and appear to be more about giving consultants something new to sell than about improving the Six Sigma Paradigm. Into this category I would place Lean Six Sigma (and the variant titles); for the most part it is bolting Lean tools into the Six Sigma framework in a way that savvy practitioners had already done informally. It fails to engage with the aspects of Lean which challenge Six Sigma (mass involvement versus expert led, for example). Design for Six Sigma appears to offer more hope, but closer examination shows that in a lot of applications it stifles innovation just as much as Six Sigma can by focusing on strict processes for risk reduction rather than supporting innovation.

Perhaps the most promising ideas are those that attempt to genuinely address the issues raised with Six Sigma in this chapter, these tend to revolve around combination with bigger concepts such as Excellence Models or TQM principles, which are much more challenging and promising on issues of leadership, people, innovation etc. Of most interest are the attempts to combine Six Sigma with Organizational Learning principles. There does seem to be a genuine synergy between these two approaches. And this logic, while not perhaps bringing us full circle, leads us back to the work of Jack Welch at GE. He has stated time and again that he had to turn GE into a learning organization before it was ready for Six Sigma; the GE workout process was a critical pre-cursor to Six Sigma (Ulrich et al, 2002). Sadly, few appear to have heeded his words despite lauding his contribution.

21.4 Summary

Despite the real benefits Six Sigma can, and does bring, to organizations Kwak and Anbari (2006) point out that it is not the solution to all business problems. Used appropriately as part of the way organizations tackle business transformation and in conjunction with broader principles, it has much merit. Unfortunately it has often been hijacked by reductive thinkers who see short term problem solving and cost reduction as the way to drive organizational success. This makes Six Sigma just another way of squeezing more out of our creaking processes and, worse, our people.

A Final Thought

“The significant problems we face cannot be solved at the same levels of thinking we were at when we created them”

Albert Einstein

I joined MITAS because
I wanted **real responsibility**

The Graduate Programme
for Engineers and Geoscientists
www.discovermitas.com



Month 16
I was a construction supervisor in the North Sea advising and helping foremen solve problems

Real work
International opportunities
Three work placements





Review & Discussion Questions:

1. *Review the Six Sigma approach against the EFQM Excellence Model:*
 - a. *Which aspects does it address?*
 - b. *How effectively?*
 - c. *Which does it not consider?*
2. *How does Lean Six Sigma differ from Six Sigma? How significant are these differences?*
3. *Consider how Organizational Learning principles might be incorporated into Six Sigma.*

22 References

- Abramowich, E. (2005) *Six Sigma for growth. Driving profitable top-line results*. John Wiley and Sons (Singapore).
- Anderson, R., Eriksson, H. & Torstensson, H. (2006) Similarities and differences between TQM, Six Sigma and Lean. *TQM Magazine*, 18(3), pp282-296.
- Antony, J., Antony, F.J., Kumar, M. & Cho, R. (2007) Six Sigma in Service Organizations: Benefits, challenges, difficulties, common myths and success factors. *International Journal of Quality and Reliability Management*. 24(2/3), pp.294-311.
- Antony, J. (2006) Six sigma for service processes. *Business Process Management Journal*, 12(2), pp234-248.
- Antony, J., Banuelas, R. (2002) Key ingredients for the effective implementation of Six Sigma programs. *Measuring Business Excellence*, 6(4), pp20-27.
- Antony, J., Banuelas, R. (2001) Six Sigma a business strategy for manufacturing organisations. *Manufacturing Engineering*, 8, pp119-121
- Antony, J., Escamilla, J.L., Caine, P., (2003) Lean Sigma. *Manufacturing Engineer*, 82(4), pp40-42.
- Argyris, C. (1994) Good communication that blocks learning. *Harvard Business Review*, July-August, 78-82.
- Banuelas, R., Antony, J. (2002) Critical success factors for implementation Six Sigma in organizations. *TQM Magazine*, 14(2), pp92-99.
- Banuelas, R., Antony, J., Brace, M. (2005) An Application of Six Sigma to Reduce Waste. *Quality and Reliability Engineering International*, 21(1), pp553-570.
- BBC Video (1992) *Business Matters: A Prophet Unheard*
- Bicheno, J. & Holweg, M. (2008) *The Lean Toolbox: The Essential Guide to Lean Transformation*, Piccie Books, London, UK.
- Breyfogle, F.W. (1999) *Implementing Six Sigma: Smarter Solutions Using Statistical Methods*, John Wiley and Sons, New York, NY.
- Businessballs.com (2011) http://www.businessballs.com/dtiresources/performance_measurement_management.pdf, Accessed August, 2011.
- Catherwood, P., (2002) What's different about Six Sigma. *Manufacturing Engineer*, 81(8), pp186-189.

Checkland, P. (1985). Achieving 'Desirable and Feasible' Change: An Application of Soft Systems Methodology. *Journal of the Operational Research Society*, Vol. 36 , 821-831.

Checkland, P. (1999). Soft Systems Methodology: a 30-year retrospective. In P. Checkland, *Systems Thinking, Systems Practice: Includes a 30-year retrospective* John Wiley & Sons, Chichester.

Cho, Hee-Jae., Pucik, V. (2005) Relationship between innovativeness, quality, growth, profitability, and market value. *Strategic Management Journal*, 26, pp555-575.

Dalglish, S., (2003) My ideal quality system. *Quality*, 42(7), pp1.

Defoe, J.A. and Juran, J.M. (2010) *Juran's Quality Handbook: The Complete Guide to Performance Excellence*. McGraw-Hill, New York.

De Mast, J. (2006) Six Sigma and competitive advantage. *Total Quality Management and Business Excellence*, 17(4), pp. 455-464.

Deming, W.E. (1990) *The New Economics*. MIT CAES, Cambridge, MA.

Dixon, N.M. (1994) *The Organizational Learning Cycle: How We Can Learn Effectively*, McGraw Hill, London.

Eckes, G. (2001) *Making Six Sigma Last: Managing the Balance Between Cultural and Technical Change*, John Wiley and Sons, New York, NY.

ie business school

#1 EUROPEAN BUSINESS SCHOOL
FINANCIAL TIMES 2013

#gobeyond

MASTER IN MANAGEMENT

Because achieving your dreams is your greatest challenge. IE Business School's Master in Management taught in English, Spanish or bilingually, trains young high performance professionals at the beginning of their career through an innovative and stimulating program that will help them reach their full potential.

- Choose your area of specialization.
- Customize your master through the different options offered.
- Global Immersion Weeks in locations such as London, Silicon Valley or Shanghai.

Because you change, we change with you.

www.ie.edu/master-management | mim.admissions@ie.edu | f t in YouTube

Download free eBooks at bookboon.com



- Feigenbaum, A.V. (1961) *Total Quality Control*, McGraw Hill.
- Flaherty, M. (2004) Lifting the Lid: Six Sigma is no longer enough [Online] *Forbes News*. <http://www.forbes.com/business/newswire/2004/05/13/rtr1371201.html> (Last Accessed 26 July 2006).
- Fleming, J.H., Coffman, C., & Harter, J. (2005) Manage your human sigma. *Harvard Business Review*, 83(7/8), pp107-114.
- Folaron, J., Morgan, J.P. (2003) The evolution of Six Sigma, *ASQ Six Sigma Forum Magazine*, 2(4), pp38-45.
- Fuller, H.T., (2000) Observations about the success and evolution of Six Sigma at Seagate. *Quality Engineering*, 12(3), pp. 311-315.
- George, M. (2002) *Lean Six sigma – Combining Six Sigma Quality with Lean Speed*. McGraw-Hill: New York.
- Gijo, E.V. & Rao, T.S. (2005) Six Sigma implementation – hurdles and more hurdles. *Total Quality Management and Business Excellence*, 16(6), pp. 721-725.
- Gilbert, B. (2002) Sick Sigma? [Online] <http://www.contextmag.com/archives/200208/Feature2SickSigma.asp>
- Gillet and Seddon (2009) *Working with the Grain: Uncommon sense for Leaders*. Process Management International Limited, Birmingham, UK.
- Goetsch, D.L. & Davis, S.B. (2010) *Quality Management for Organizational Excellence: Introduction to Total Quality*. Pearson, NJ.
- Goh, T.N., (2010) Six triumphs and six tragedies of Six Sigma. *Quality Engineering*, 22(4), pp. 299-305.
- Goh, T.N. (2002) A strategic assessment of Six Sigma. *Quality and Reliability Engineering International*, 18(5), pp403–410.
- Goh, T.N., Low, P.C., Tsui, K.L., Xie, M. (2003) Impact of Six Sigma implementation on stock price performance. *TQM & Business Excellence*, 14(7), pp753-763.
- Goldstein, M. (2001) Six Sigma program success factors. *Six Sigma Forum magazine*, November, pp36-45.
- Gupta, P. (2008) Reducing the cost of failures. *Quality Digest*, 47(1), pp.22.
- Gutierrez, L.J.G., Bustinza, O.F. & Molina, V.B. (2011) Six Sigma, absorptive capacity and organizational learning orientation. *International Journal of Production Research*, pp. 1-15.
- Hahn, G.J. (2005) Six Sigma: 20 Key Lessons Learned. *Quality and Reliability Engineering International*, 21, pp225–233.
- Hammer, M. (2002) Process management and the future of Six Sigma. *MIT Sloan Management Review*, 43(2), pp26-32.

- Harry, M. (1998) Six Sigma: A breakthrough strategy for profitability. *Quality Progress*, 31(5), pp60-64.
- Harry, M.J., Schroeder R. (1999) *Six Sigma: The Breakthrough Management Strategy Revolutionizing the World's Top Corporations*. New York: Doubleday.
- Immelt, J. (2005) Bringing Innovation to The Home of Six Sigma. *BusinessWeek*, 3945, 1.8.2005.
- Ingle, S., Roe, W. (2001) Six Sigma black belt implementation. *The TQM Magazine*, 13(4), pp273-280.
- Ishikawa, K. (1989) *Guide to Quality Control*. Asian Productivity Organization, Tokyo.
- Jones, E.C., Parast, M.M. & Adams, S.G. (2010) A framework for effective Six Sigma implementation. *Total Quality Management and Business Excellence*, 21(4), pp. 415-424.
- Kano, N., Nobuhiku, S., Fumio, T., Shinichi, T. (1984). Attractive quality and must-be quality (in Japanese). *Journal of the Japanese Society for Quality Control*, 14 (2), pp39-48.
- Keller, P. (2001) *Six Sigma Demystified: a self-teaching guide*. McGraw Hill, NY.
- Kets de Vries, M.F.R. & Miller, D. (1984) *The Neurotic Organisation*. Jossey Bass, San Francisco.
- Klefsjo, B., Wiklund, H. & Edgeman, R.L. (2001) Six Sigma seen as a methodology for total quality management. *Measuring Business Excellence*, 5(1), pp. 31-36.
- Knowles, G. and Anthony, J. (2002) "Six Sigma and Organisational Learning: An Opportunity Missed?" *Sixth International Research Conference on Quality, Innovation and Knowledge*, Malaysia.
- Knowles G., Whicker L., Femat J. and Del Campo Canales F. (2005) A Conceptual Model for the Application of Six Sigma Methodologies to Supply Chain Improvement, *International Journal of Logistics: Research and Applications*, 8(1), pp. 1-15.
- Kotter, J.P. 1996 *Leading Change*. Harvard Business Press, MA.
- Kumar, M., Antony, J., Singh, R. K., Tiwari, M. K. & Perry, D. (2006) Implementing the Lean Sigma framework in an Indian SME: a case study. *Production Planning and Control*, 17 (4), pp. 407-423.
- Kwak Y.H., Anbari, F.T. (2006) Benefits, obstacles, and future of six sigma approach, *Technovation*, 26, pp708-715
- Leavenworth, S. (2004) <http://www.ive.cuny.edu/downloads/cases/Southwest%20Airlines%20IVE%20Case.pdf>. Accessed August, 2011.
- Lee K-L. (2002) *Critical Success Factors of Six Sigma implementation and the impact on operations performance*. PhD thesis, the University of Cleveland

- Lee, C. (2001) Why you can safely ignore Six Sigma. *Fortune*, 22 January.
- Lee, Y-C., Lin, S-B., & Wang, Y-L. (2011) A new Kano's Evaluation Sheet. *The TQM Journal*, 23 (2), pp. 179-195.
- Lencioni, P. M. (2002) Make your values mean something. *Harvard Business Review*; July, pp5-9. Maslow, A. H. (1987) *Motivation and Personality* (3rd ed), Harper and Row, New York.
- McAdam, R. & Lafferty, B. (2004) A multilevel case critique of Six Sigma: statistical control or strategic change? *International Journal of Operations & Production Management*, 24, pp. 530-549.
- McAdam, R., Hazlett, S., Henderson, J. (2005) A critical review of Six Sigma: exploring the dichotomies. *International Journal of Organizational Analysis*, 13(2), pp151-174.
- McHugh, D., Groves, D. and Alker, A. 1998. Managing learning: what do we learn from a learning organization? *The Learning Organization*. 5 (5) pp.209-220.
- Moosa, K., & Sajid, A. (2010) Critical analysis of Six Sigma implementation. *Total Quality Management and Business Excellence*, 21(7), pp. 745-759.
- Murphy, T. (1998) Close enough to perfect. *Ward's Auto World*, 34(8).
- Murugappan, M., Keeni, G., (2003) Blending CMM and six sigma to meet business goals. *IEEE Software*, March.
- Pande, P.S., Neuman, R.P. and Cavanagh, R.R. (2000), *The Six Sigma way: How GE, Motorola, and Other Top Companies are Honing Their Performance*, McGraw-Hill, NY.
- Pande, P. S. (2002) *What is six sigma?* New York : McGraw-Hill.**
- Parr, C.W. (2006) Making Six Sigma Last, *ASQ Six Sigma Forum Magazine*, 5(2), pp15-21.
- PCworld.com (2010) http://www.pcworld.com/article/202625/survey_most_iphone_4_users_very_satisfied.html?tk=hp_blg, Accessed August, 2011.
- Pedler, M., Burgoyne, J. & Boydell, T. (1997) *The Learning Company*, McGraw-Hill, Maidenhead, Berks, UK.
- Peters, T. & Waterman R.H. (2004) *In Search of Excellence: Lessons from America's Best Run Companies*. Profile Books.
- Raisinghani, S.M., Ette, H., Pierce, R., Cannon, G., Daripaly, P. (2005) Six Sigma: concepts, tools, and applications. *Industrial Management and Data Systems*, 105(3/4), pp491-505.
- Rasche, K. (2001) The Emperor's New Woes. Letters. [Online] <http://www.qualitydigest.com/july01/html/letters.html> (Last Accessed 26 July 2006)

- Revere, L., Black, K., (2003) Integrating six sigma with total quality management: a case example for measuring medication errors. *Journal of Healthcare Management*, 48(6), pp377–391.
- Rucker, R. (2000) Citibank increases customer loyalty with defect free processes. *Journal of Quality and Participation*, 23(4), pp. 32-36.
- Sarmiento, R., Beale, J. and Knowles, G. (2007) Determinants of performance amongst shop-floor employees: A preliminary investigation. *Management Research News*, 30 (12), pp. 915-927.
- Schroeder, R.G., Linderman, K., Liedtke, C.& Choo, A.S. (2008) Six Sigma: definition and underlying theory. *Production and Operations Management*, 14 (4), pp. 468-481.
- Seddon, J. (2006) The black belts bite back. *Vanguard Newsletters*, January, [Online] <http://www.lean-service.com/6-news-jan-06.asp#1> (Last Accessed 26 July 2006).
- Semler, R. (1993) *Maverick! The Success Story Behind The World's Most Unusual Workplace*. Arrow Business Books, London.
- Senapati, N.R. (2004) Six Sigma: myth and realities. *International Journal of Quality & Reliability Management*, 21, pp683-690.
- Senge, P.M. (1999) *The Fifth Discipline: The Art and Practice of The Learning Organization*. Random House, London.
- Shelley, A., Wilson, D. (2002) *Six Sigma's Mission Impossible. Part I*. [Online] <http://communities.msn.com/SixSigmaProblemsAndSolutions> (Last Assessed 16 July 2006).
- Shewhart W.A. (1980) *Economic Control of Quality of Manufactured Product*. ASQC Quality Press; NY.
- Shiba, S., Graham, A. & Walden, D. (1993) *A New American TQM: Four Practical Revolutions in Management*. Productivity Press, Portland, OR.
- Skinner, J.T. (1989) The US Air force 'Blue Two' Visit Program. *Paper presented at IEEE Reliability and Maintainability Symposium*, 24th-26th January.
- Smith, P.A.C. & Tosey, P. (1999) Assessing The Learning Organization: Part 1- Theoretical Foundations *The Learning Organization*, 6 (2), pp. 70-75.
- Snee, R. (1999) Why Should Statisticians Pay Attention to Six Sigma? *Quality Progress*, September, pp100-103.
- Taguchi, G. (1986) *Introduction to Quality Engineering*. Asian Productivity Organization, Tokyo.
- Tennant, C. & Roberts, P.A.B.R. (2001) Hoshin Kanri: implementing the catchball process. *Long Range Planning*, 34, pp. 287-308.

- Thawani, S. (2004) Six Sigma-Strategy for Organizational Excellence. *Total Quality Management and Business Excellence*, 15(5), pp655-664.
- Ulrich, D. & Lake, D. (1990) *Organizational Capability: Competing from the Inside Out*. John Wiley, NY.
- Ulrich, D., Kerr, S. & Ashkenas, R. (2002) *The GE Work Out*. McGraw Hill, NY.
- Voelkel, G.J. (2005) What Makes a Six Sigma Project Successful? *Quality Progress*, 38(5), pp66-69.
- Weick, K.E., Sutcliffe, K. M. & Obstfeld, D. (2005) Organizing and the process of sense making, *Organization Science*, 16(4), pp409-421.
- Wiklund, H., Wiklund, P.S. (2002) Widening the Six Sigma concept: An approach to improve organizational learning. *Total Quality Management*, 13(2), pp233-239.
- Wheeler D.J. (1993) *Understanding Variation: The Key to Managing Chaos*. SPC Press, Knoxville, TN.
- Wheeler, D. (1995) *Advanced Topics in Statistical Process Control*. SPC Press, Knoxville, TN.
- Wheeler D.J. & Chambers D.A. (1992) *Understanding Statistical Process Control*. SPC Press, Knoxville, TN
- Wheeler, D. & Lyday, R.W. (1990) *Evaluating the Measurement Process*. SPC Press, Knoxville, TN
- Whitney, D., Trosten-Bloom, A., Cooperrider, D. (2010) *The Power of Appreciative Inquiry: A Practical Guide to Positive Change*. Berrett-Koehler Publishers.
- Wikipedia.org (2011) <http://upload.wikimedia.org/wikipedia/commons/6/67/Vsm-epa.gif>. Last Accessed September 2011.
- Wyper, B., Harrison, A., (2000) Deployment of six sigma methodology in human resource function: a case study. *Total Quality Management and Business Excellence*, 11(4-5), pp720-727.
- Yang, K. & El Haik, B. (2002), *Design for Six Sigma: A Roadmap for Product Development*. McGraw-Hill, NY.
- Yang, C-C. & Yeh, T-M. (2007) An integrated model of Hoshin Management and Six Sigma in high-tech firms. *Total Quality Management and Business Excellence*, 18(6), pp. 653-665.
- Zeithaml, V.A., Parasuraman, A. & Berry, L.L. (1990) *Delivering Quality Service; Balancing Customer Perceptions and Expectations*. Free Press.
- Zimmerman, J.P. & Weiss, J. (2005) Six Sigma's seven deadly sins. *Quality*, 44(1), pp. 62-66.